

# UTA-31893

## Tango 32 Square Asymmetrical Up/Downlight



### Construction

**Aluminum.**  
Less than 0.1% copper content - Marine Grade 6060 extruded & LM6 Aluminum High Pressure die casting provides excellent mechanical strength, clean detailed product lines and excellent heat dissipation.

**Pre paint**  
8 step degrease and phosphate process that includes deoxidizing and etching as well as a zinc and nickel phosphate process before product painting.

**Memory Retentive -Silicon Gasket**  
Provided with special injection molded "fit for purpose" long life high temperature memory retentive silicon gaskets. Maintains the gaskets exact profile and seal over years of use and compression.

**Thermal management**  
LM6 Aluminum is used for its excellent mechanical strength and thermal dissipation properties in low and high ambient temperatures. The superior thermal heat sink design by Ligman used in conjunction with the driver, controls thermals below critical temperature range to ensure maximum luminous flux output, as well as providing long LED service life and ensuring less than 10% lumen depreciation at 50,000 hours.

**Surge Suppression**  
Standard 10kv surge suppressor provided with all fixtures.

**BUG Rating**  
B1 - U5 - G1

**Finishing.**  
All Ligman products go through an extensive finishing process that includes fettling to improve paint adherence.

**Paint**  
UV Stabilized 4.9Mil thick powder coat paint and baked at 200 Deg C. This process ensures that Ligman products can withstand harsh environments. Rated for use in natatoriums.

**Inspired by Nature Finishes**  
The Inspired by nature Finishing is a unique system of decorative powder coating. Our metal decoration process can easily transform the appearance of metal or aluminum product into a wood grain finish.

This patented technology enables the simulation of wood grain, and even marble or granite finish through the use of decorative powder coating.

The wood grain finish is so realistic that it's almost undistinguishable from real wood, even from a close visual inspection. The system of coating permeates the entire thickness of the coat and as a result, the coating cannot be removed by normal rubbing, chipping, or scratching.

**The Coating Process**  
After pre-treatment the prepared parts are powder coated with a specially formulated polyurethane powder. This powder provides protection against wear, abrasion, impact and corrosion and acts as the relief base color for the finalized metal decoration.

The component is then wrapped with a sheet of non-porous film with the selected decoration pattern printed on it using special high temperature inks.

This printed film transfer is vacuum-sealed to the surface for a complete thermo print and then transferred into a customized oven. The oven transforms the ink into different forms within the paint layer before it becomes solid. Finally, the film is removed, and a vivid timber look on aluminum remains.

Wood grain coating can create beautiful wood-looking products of any sort. There are over 300 combinations of designs currently in use. Wood grains can be made with different colors, designs, etc.

Our powder coatings are certified for indoor and outdoor applications and are backed by a comprehensive warranty. These coatings rise to the highest conceivable standard of performance excellence and design innovation.

**Added Benefits**

- Resistance to salt-acid room, accelerated aging
- Boiling water, lime and condensed water resistant
- Anti-Graffiti, Anti-Slip, Anti-Microbial, Anti-Scratch
- Super durable (UV resistant)
- TGIC free (non-toxic)

**Hardware**  
Provided Hardware is Marine grade 316 Stainless steel.

**Anti Seize Screw Holes**  
Tapped holes are infused with a special anti seize compound designed to prevent seizure of threaded connections, due to electrolysis from heat, corrosive atmospheres and moisture.

**Crystal Clear Low Iron Glass Lens**  
Provided with tempered, impact resistant crystal clear low iron glass ensuring no green glass tinge.

**Optics & LED**  
Precise optic design provides exceptional light control and precise distribution of light.  
LED CRI > 80

**Lumen - Maintenance Life**  
L80 /B10 at 50,000 hours (This means that at least 90% of the LED still achieve 80% of their original flux)

**Circular or square form technical up & down-light wall range. Completely tailorable wall-mounted direct/indirect optical lighting solutions for perfect task or architectural lighting.**

Wall luminaires with a selection of light distributions and LED wattages with downward light distributions. The Tango is unique as it is available with Type II, III & IV light distribution options that facilitates wider spacing and even light distribution between the light fixtures.

Spacings of up to 40' on center, and a 14' mounting height with a 2 fc average can be achieved using the type II optic. This provides higher energy saving and reduced installation costs.

The Tango 31 cylindrical or Tango 32 square up-down versions can be manufactured using different type beam distributions for the up and down optics. Integral electronic control gear. Mounting plate for 3" and 4" junction box is provided with the fixture.

Matching surface mount conduit boxes are available as an option. Custom round pole adapters can be manufactured to suit specific pole diameters for column mounting applications. Please contact the factory for more information.

2x29w LED 2x2541 Lumens  
IP65 • Suitable For Wet Locations  
IK08 • Impact Resistant (Vandal Resistant)  
Weight 18.5 lbs

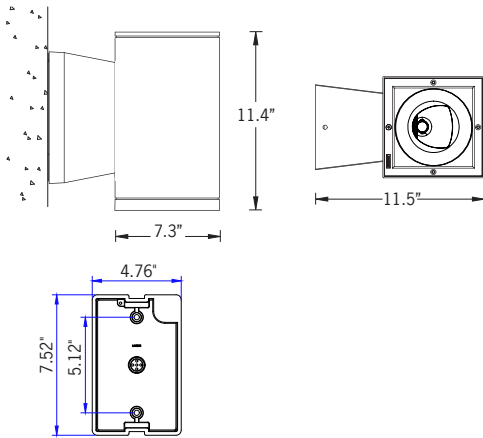

Mounting Detail



Ligman's micro Variable Optical System provides the ability to interchange, mix & rotate optics to provide specific light distributions for optimized spacing and uniformity.

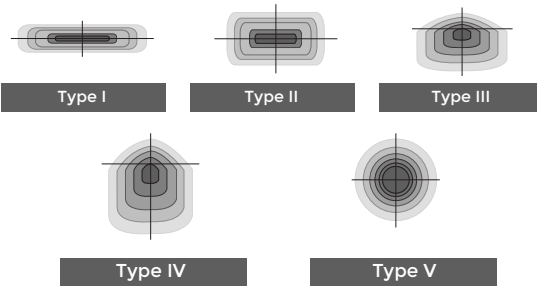

The variable optic system allows for the designer to create hybrid distributions for precise lighting requirements.

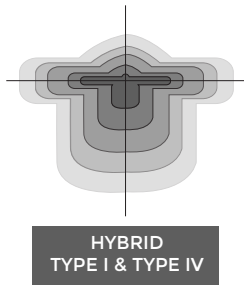

### Additional Options (Consult Factory For Pricing)



**RPA**  
Round Pole Adapter



**AGL**  
Anti Glare Louvre

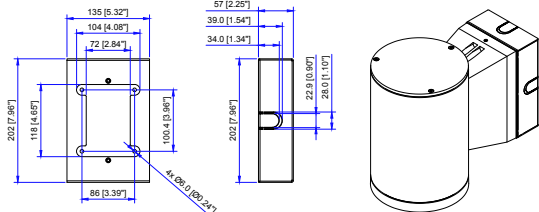

**SCBT**  
Surface Conduit Box Trim

NOTE: This trim covers a shallow single gang, surface mount junction box (Provided by contractor)  
Example: Hubbell - 5322-0 - 1-Gang Weatherproof Box, Five 1/2" in. Threaded Outlets - or - 5332-0 - 1-Gang Weatherproof Box, Five 3/4 in. Threaded Outlets

# UTA-31893

Tango 32 Square Asymmetrical Up/Downlight

<b>PROJECT</b>	<input type="text"/>	<b>DATE</b>	<input type="text"/>
----------------	----------------------	-------------	----------------------

<b>QUANTITY</b>	<input type="text"/>	<b>TYPE</b>	<input type="text"/>	<b>NOTE</b>	<input type="text"/>
-----------------	----------------------	-------------	----------------------	-------------	----------------------

ORDERING EXAMPLE || UTA - 31893 - 2x29w - AS - W30 - 02 - 120/277v - Options

<b>UTA-31893</b>	<input type="text"/>	<input type="text"/>	<input type="text"/>	<input type="text"/>	<input type="text"/>
	<b>LAMP</b>	<b>BEAM</b>	<b>LED COLOR</b>	<b>FINISH COLOR</b>	<b>VOLTAGE</b>
	2x29w LED 2x2541 Lumens	AS - Asymmetrical Beam 46"x56"	W27 - 2700K W30 - 3000K W35 - 3500K W40 - 4000K	01 - BLACK RAL 9011 02 - DARK GREY RAL 7043 03 - WHITE RAL 9003 04 - METALLIC SILVER RAL 9006 05 - MATTE SILVER RAL 9006 06 - LIGMAN BRONZE 07 - CUSTOM RAL	120/277v Other - Specify

<input type="text"/>	<input type="text"/>	<input type="text"/>	<input type="text"/>
----------------------	----------------------	----------------------	----------------------

## ADDITIONAL OPTIONS

- NAT - Natatorium Rated
- SCBT - Surface Conduit Box Trim
- DIM - 0-10v Dimming
- F - Frosted Lens
- AGL - Anti Glare Louvre
- EMG - Emergency Battery Pack
- RPA - Round Pole Adapter
- HGT - Custom Height
- AMB - Turtle Friendly Amber LED

**INSPIRED BY NATURE FINISHES**

- SW01 - OAK FINISH
- SW02 - WALNUT FINISH
- SW03- PINE FINISH
- DF - DOUGLAS FIR FINISH
- CW - CHERRY WOOD FINISH
- NW - NATIONAL WALNUT FINISH
- SU01 - CONCRETE FINISH
- SU02 - SOFTSCAPE FINISH
- SU03 - STONE FINISH
- SU04 - CORTEN FINISH

THERE IS AN ADDITIONAL COST FOR THESE FINISHES

## More Custom Finishes Available Upon Request

Consult factory for pricing and lead times



# Tango Product Family



**Tango 29**

- UTA-31861-37w-2777lm - Down
- UTA-31861-29w-2566lm [ASYM] - Down
- UTA-31863-42w-3418lm [ASYM] - Down



**Tango 30**

- UTA-31871-37w-2777lm - Down
- UTA-31871-29w-2566lm [ASYM] - Down
- UTA-31873-42w-3418lm [ASYM] - Down



**Tango 31**

- UTA-31881-2x37w-2x2777lm - Up/Down
- UTA-31882-2x29w-2x3521lm [ASYM] - Up/Down
- UTA-31883-2x42w-2x3418lm [ASYM] - Up/Down

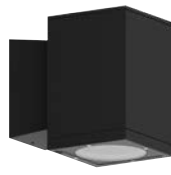

**Tango 32**

- UTA-31891-2x37w-2x3521lm - Up/Down
- UTA-31892-2x39w-2x2566lm [ASYM] - Up/Down
- UTA-31893-2x29w-2x2777lm [ASYM] - Up/Down



**Tango 33**

- UTA-80551-37w-2777lm
- UTA-80552-29w-2566lm [ASYM]
- UTA-80553-42w-3418lm [ASYM]



**Tango 34**

- UTA-80561-37w-2777lm
- UTA-80562-29w-2566lm [ASYM]
- UTA-80563-42w-3418lm [ASYM]

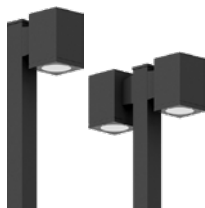

**Tango 35**

- UTA-20731-37w-2777lm
- UTA-20732-2x37w-2x2777lm



**Tango 36**

- UTA-20001-38w-4265lm
- UTA-20011-37w-2777lm



**Tango 37**

- UTA-20021-2x38w-2x4265lm
- UTA-20022-2x37w-2x2777lm

