

4x33w LED
4x1158 Lumens

IP65
Suitable for wet locations

IK08
Impact Resistant [Vandal Resistant]

Weight 142.4 lbs

Construction

Aluminum
Less than 0.1% copper content – Marine Grade 6060 extruded & LM6 Aluminum High Pressure die casting provides excellent mechanical strength, clean detailed product lines and excellent heat dissipation.

Pre paint
8 step degrease and phosphate process that includes deoxidizing and etching as well as a zinc and nickel phosphate process before product painting.

Memory Retentive -Silicon Gasket
Provided with special injection molded "fit for purpose" long life high temperature memory retentive silicon gaskets. Maintains the gaskets exact profile and seal over years of use and compression.

Thermal management
LM6 Aluminum is used for its excellent mechanical strength and thermal dissipation properties in low and high ambient temperatures. The superior thermal heat sink design by Ligman used in conjunction with the driver, controls thermals below critical temperature range to ensure maximum luminous flux output, as well as providing long LED service life and ensuring less than 10% lumen depreciation at 50,000 hours.

Surge Suppression
Standard 10kv surge suppressor provided with all fixtures.

BUG Rating
Contact Factory

Finishing
All Ligman products go through an extensive finishing process that includes fettling to improve paint adherence.

Paint
UV Stabilized 4.9Mil thick powder coat paint and baked at 200° C. This process ensures that Ligman products can withstand harsh environments. Rated for use in natatoriums.

Inspired by Nature Finishes
The Inspired by nature Finishing is a unique system of decorative powder coating. Our metal decoration process can easily transform the appearance of metal or aluminum product into a wood grain finish.

This patented technology enables the simulation of wood grain, and even marble or granite finish through the use of decorative powder coating.

The wood grain finish is so realistic that it's almost undistinguishable from real wood, even from a close visual inspection. The system of coating permeates the entire thickness of the coat and as a result, the coating cannot be removed by normal rubbing, chipping, or scratching.

The Coating Process
After pre-treatment the prepared parts are powder coated with a specially formulated polyurethane powder. This powder provides protection against wear, abrasion, impact and corrosion and acts as the relief base color for the finalized metal decoration.

The component is then wrapped with a sheet of non-porous film with the selected decoration pattern printed on it using special high temperature inks.

This printed film transfer is vacuum-sealed to the surface for a complete thermo print and then transferred into a customized oven. The oven transforms the ink into different forms within the paint layer before it becomes solid. Finally, the film is removed, and a vivid timber look on aluminum remains.

Wood grain coating can create beautiful wood-looking products of any sort. There are over 300 combinations of designs currently in use. Wood grains can be made with different colors, designs, etc.

Our powder coatings are certified for indoor and outdoor applications and are backed by a comprehensive warranty. These coatings rise to the highest conceivable standard of performance excellence and design innovation.

- Added Benefits**
- Resistance to salt-acid room, accelerated aging
 - Boiling water, lime and condensed water resistant
 - Anti-Graffiti, Anti-Slip, Anti-Microbial, Anti-Scratch
 - Super durable (UV resistant)
 - TGIC free (non-toxic)

Hardware
Provided Hardware is Marine grade 316 Stainless steel.

Anti Seize Screw Holes
Tapped holes are infused with a special anti seize compound designed to prevent seizure of threaded connections, due to electrolysis from heat, corrosive atmospheres and moisture.

Crystal Clear Low Iron Glass Lens
Provided with tempered, impact resistant crystal clear low iron glass ensuring no green glass tinge.

Optics & LED
Precise optic design provides exceptional light control and precise distribution of light.
LED CRI > 80

Lumen - Maintenance Life
L80 /B10 at 50,000 hours (This means that at least 90% of the LED still achieve 80% of their original flux)

Total urban realm lighting solution.
Optional heights, accent spotlights, accessories and decorative lattice panels.

A stylish Dark Sky Compliant square high performance light column with downward light distribution using LED lamps. This light column offers optimal visual comfort through glare control by utilizing a controlled optics designed by Ligman. These columns have a square design providing a unique wide light distribution, offering an architecturally appealing clover leaf pattern on the paving. The internal sides of the supporting pillars are accented by light from the LED.

Color temperature 2700K, 3000K, 3500K and 4000K. The minimalistic shape provides distinctive lighting effects by night and decorative urban effect during the day. Suitable for pedestrian areas, precincts, building surroundings, shopping centers, squares and parks. The Vancouver Column comes standard with a unique waterproof internal driver housing compartment that is situated at the top of the pole to stop water and dust from entering the electrical components.

This fixture is supplied completely wired with powercord and waterproof gland from the driver enclosure to the base of the column to ensure quick trouble-free installation. The Vancouver has a specially designed anchor bolt mounting base that is partially buried below ground level to provide a flush fixture finish with the surface, but maintains the rigidity that is required when installing light columns. This ensures that the anchor bolts are not seen and therefore eliminates the necessity for an anchor bolt cover. (review installation instructions before installing the anchor bolts.)

Custom column heights are available, please specify. Provided with anchor bolts (the root mount kit is an option and is an adder)

Reduced custom wattages can be provided to suit customer requirements. (Specify total watt requirement per fixture) Designed to complement the Vancouver bollard UVA-10001. This product is provided complete with anchor bolts and laser cut steel bolt template.

• **NOTE: For the round version of the Vancouver, please see the [Benton Light Column and Bollard](#)**

Additional Options (Consult Factory For Pricing)

RGBW

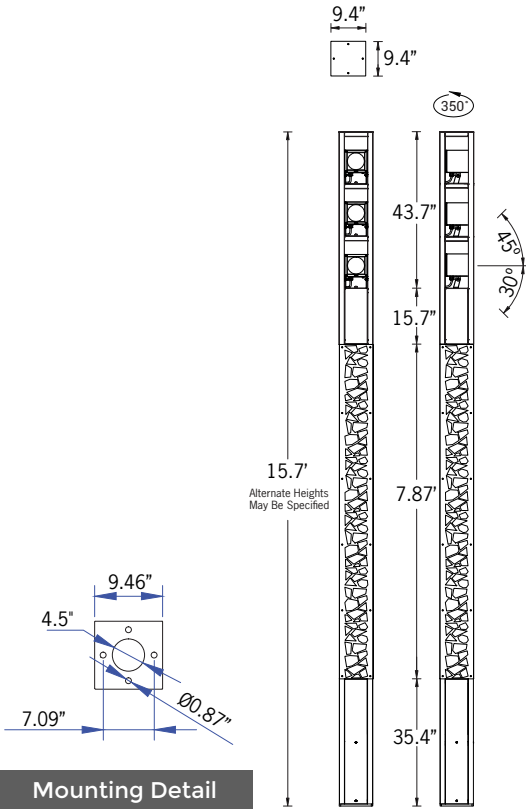

Mounting Detail

UVA-20123

Vancouver 17 Light Column

PROJECT		DATE	
----------------	--	-------------	--

QUANTITY		TYPE		NOTE	
-----------------	--	-------------	--	-------------	--

ORDERING EXAMPLE || UVA - 20123 - 4x33w - M - RGBW30 - 02 - 120/277v - Options

UVA-20123					
LAMP	BEAM	RGBW COLOR	FINISH COLOR	VOLTAGE	
4x33w LED 4x1158 Lumens	N - Narrow 21° M - Medium 35° E - Elliptical 48° x 26°	RGBW30 - Warm White 3200K RGBW40 - Neutral White 4000K RGBW65 - Cool White 6850K	01 - BLACK RAL 9011 02 - DARK GREY RAL 7043 03 - WHITE RAL 9003 04 - METALLIC SILVER RAL 9006 05 - MATTE SILVER RAL 9006 06 - LIGMAN BRONZE 07 - CUSTOM RAL	120/277v Other - Specify	

--	--	--

ADDITIONAL OPTIONS

- NAT - Natatorium Rated
- DIM - 0-10v Dimming
- HGT - Custom Height (Specify)
- A20991 - Root Mount Kit
- GFCI - GFCI Box

- A68391 - STICK-DE3
- A64491 - TPC + DMX Controller
- A64591 - POE Connect
- A64691 - TPC + DMX 2
- A64791 - RDM DMX Splitter
- A65191 - TPC Touch Panel
- A65391 - EDN Ethernet Data Node
- A66991 - LPCX Lighting Playback
- A64991 - CLOUD



INSPIRED BY NATURE FINISHES

SW01 - OAK FINISH	
SW02 - WALNUT FINISH	
SW03 - PINE FINISH	
DF - DOUGLAS FIR FINISH	
CW - CHERRY WOOD FINISH	
NW - NATIONAL WALNUT FINISH	
SU01 - CONCRETE FINISH	
SU02 - SOFTSCAPE FINISH	
SU03 - STONE FINISH	
SU04 - CORTEN FINISH	

THERE IS AN ADDITIONAL COST FOR THESE FINISHES

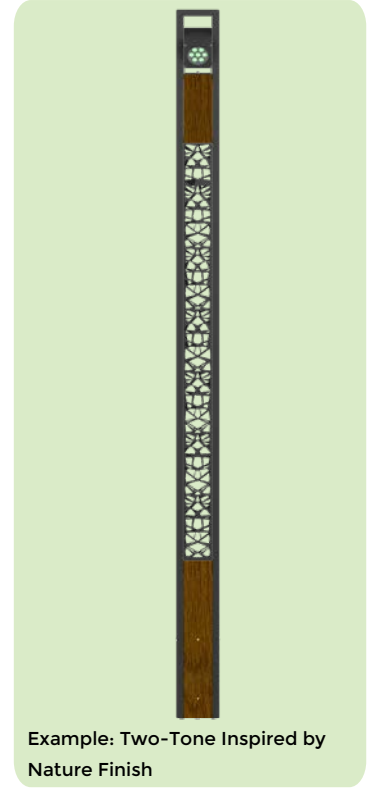



TPC Touchscreen & EXT Controller DMX & DALI 1 Universe

The TPC (Touch Panel Controller) is an elegant touch screen lighting controller with a customisable, 4.3" capacitive touch panel, 512 channels of eDMX output and vast interfacing potential, all over a single Power-over-Ethernet (PoE) network connection.

The EXT is an extension for the Pharos TPC and together they form a standalone, mainspowered lighting controller with versatile output and show control options. The EXT provides local DMX and DALI output for the TPC, as well as power and other hardware interfaces.



A64491



A64691

TPC Touchscreen & LPC Controller DMX 2 Universe

The LPC (Lighting Playback Controller) is an all-in-one control solution for themed entertainment and LED lighting installations. It features individually controllable and independently running timelines and scenes. Supported fixtures include LEDs in any configuration (RGB, RGBW, tunable white), moving heads, yokes or scanners and fountain jets. Output includes DMX512, Art-Net, DALI & RDM.

POE Connect

The POE (Power-over-Ethernet Switch) provides a simple power and networking solution for four Power-over-Ethernet devices with two separate Ethernet uplink ports. It is perfect for connecting power and data between Pharos Controllers and Pharos Remote Devices.



A64591



RDM DMX Splitters

The RDM (Remote Device Management) is a 4 port DMX512 Splitter compatible with the RDM standard to provide DMX output to luminaires and other devices. DMX splitters are an essential requirement for most control systems, allowing multiple separate cable runs from a single DMX output and ensuring electrical isolation.

A64791

TPS Touch Panel Station

The Pharos TPS (Touch Panel Station) is an elegant interface with a customizable, 4.3" capacitive touch screen, that works with any Pharos Controller



A65191



A64991

CLOUD

The CLOUD makes it easy to achieve remote control and management which is truly remote and totally secure.

Once connected, users can adjust hardware settings remotely, schedule tasks, control multiple projects, view system status, set remote user permissions, and more; through a standard internet connection without any additional hardware.

LPCX Lighting Playback Controller X

The Pharos LPC X (Lighting Playback Controller X) offers an extreme level of power and integration, making it an ideal solution for landmark lighting installations with significant channel counts. It integrates with the full range of Pharos products and offers an optional real-time video input



A66991



A65391

EDN Ethernet Data Node

The Pharos EDN (Ethernet Data Node) is a convenient and scalable solution, providing cost-effective Ethernet distributed DMX ports for large control projects. The EDN is an easily configurable networking node that is specifically designed to add physical DMX ports to Pharos Controllers and integrates natively with the full Pharos range.

Extremely compact, it packs up to 20 DMX512 output ports into a 1U 19" form factor. For higher port count installations, nodes can be daisy-chained to provide as many physical DMX ports as you need.

EDNs are discoverable through Pharos Designer software and associated to a Controller to be seamlessly configured as part of your patch. Ports can be flexibly assigned to any controller in your project providing an elegant data distribution solution over an Ethernet network with minimal setup required.

DMX/RDM Decoder - 24 VDC - Remote IP65 Box

- Control mode: RGBW / RGB / Custom / Dimming
- Compatible with DMX protocol (ANSI E1.11) and RDM function (ANSI E1.20)
- Output power: 33 W x 4 Channels (132 W max)
- Input voltage: 12-36 VDC
- Output voltage: 7.5-33 VDC



A67091



SLESA-U9

The Nicolaudie SLESA-U9 is a standalone USB based DMX256 lighting controller with 20 scenes and 1 zone. This simple and reliable control allows dynamic lighting scenes to be programmed quickly and easily through the ESA2 software for uninterrupted independent operation.



A60491



SLESA-U11

The Nicolaudie SLESA-U11 is a standalone engine (NSA) offering incredible power based DMX2048+ lighting controller with 99 scenes 5 zones, extended triggers and 16-bit channels management. Intuitive backlit keyboard with 10 presets and zone selection. Lighting scenes can be programmed quickly and easily through ESAPRO2 software via USB or Ethernet connection and mobile applications.

A66891

DMX Splitter & Amplifier in IP Box

Digital signal distributor is used with DMX512 digital lighting control signal for amplification and 2 channel distribution output. Each input/output interface adopts high voltage isolation technology, applied to DMX512 signal via remote transmission attenuation after the plastic amplification processing. Complete electrical isolation is used between the input interface and the distribution between output interface.



A63991



A67291

DINA-DR MICRO DMX Lighting Controller & Power Adapter

The DINA-DR MICRO is the perfect standalone lighting controller for simple DMX installations. It offers an affordable and programmable solution to replace automatic controllers.

Delivered with a DIN rail adapter, the DINA-DR MICRO can be mounted in an electrical cabinet and affords significant ease of installation.

Create your static or dynamic lighting scenes with ESA Pro 2 software and upload them to the DINA-DR MICRO through its USB connection. Specifications: 10 scenes, 1 zone, 60 channels.

STICK-DE3

The feature rich lighting controller has been designed to provide a control solution for the most demanding of projects, whilst maintaining an easy to use panel of touch sensitive buttons. The controller integrates a graphical color screen allowing scene photos to be displayed. Easily view the selected zone, scene name and design without the need to navigate through complex menus.

Change the speed, color and dimmer using the circular palette. The lighting levels, color and effects can be programmed from a PC, Mac, Android, iPad or iPhone using the included software



A68391

Vancouver Product Family

Vancouver 1

- UVA-20001-70w-6350lm [9.4"x9.4"-14.7]
- UVA-20001-60w-6084lm [9.4"x9.4"-14.7]
- UVA-20001-50w-5576lm [9.4"x9.4"-14.7]
- UVA-20001-40w-2969lm [9.4"x9.4"-14.7]

Vancouver 2

- UVA-20011-20w-1414lm [6.3"x6.3"-9.8]

Vancouver 3

- UVA-10001-21w-1270lm [9.4"x9.4"-39.3]

Vancouver 4

- UVA-10011-15w-837lm [6.3"x6.3"-39.3]

Vancouver 5

- UVA-20021-39/21w-1336/1673lm [9.4"x9.4"-13.3]
- UVA-20022-39/2x21w-1336/2x1673lm [9.4"x9.4"-14.5]
- UVA-20023-39/3x21w-1336/3x1673lm [9.4"x9.4"-15.7]

Vancouver 6

- UVA-20031-39/21w-1167/1673lm [9.4"x9.4"-13.3]
- UVA-20032-39/2x21w-1167/2x1673lm [9.4"x9.4"-14.5]
- UVA-20033-39/3x21w-1167/3x1673lm [9.4"x9.4"-15.7]

Vancouver 7

- UVA-20041-39/21w-1670/1673lm [9.4"x9.4"-13.3]
- UVA-20042-39/2x21w-1670/2x1673lm [9.4"x9.4"-14.5]
- UVA-20043-39/3x21w-1670/3x1673lm [9.4"x9.4"-15.7]

Vancouver 8

- UVA-20051-40w-1336lm [9.4"x9.4"-12.1]

Vancouver 9

- UVA-20061-40w-1167lm [9.4"x9.4"-12.1]

Vancouver 10

- UVA-20071-40w-1670lm [9.4"x9.4"-12.1]

Vancouver 11

- UVA-10021-21w-570lm [9.4"x9.4"-39.3]

Vancouver 12

- UVA-10031-21w-490lm [9.4"x9.4"-39.3]

Vancouver 13

- UVA-10041-21w-704lm [9.4"x9.4"-39.3]

Vancouver 14

- UVA-70001-8w-331lm [6.3"x6.3"-15.7]

Vancouver 15

- UVA-70011-21w-815lm [9.4"x9.4"-15.7]

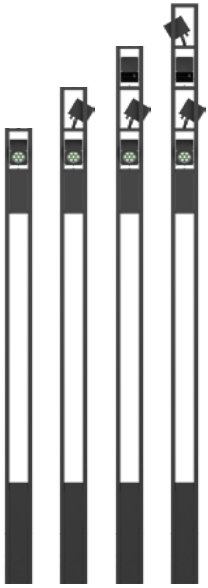

Vancouver 16

- UVA-20111-33w-1429lm [9.4"x9.4"-13.3']
- UVA-20112-66w-4287lm [9.4"x9.4"-14.5']
- UVA-20113-99w-5716lm [9.4"x9.4"-15.7']
- UVA-20114-132w-7145lm [9.4"x9.4"-17']

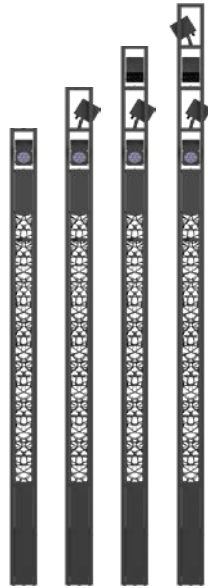

Vancouver 17

- UVA-20121-33w-2858lm [9.4"x9.4"-13.3']
- UVA-20122-66w-4287lm [9.4"x9.4"-14.5']
- UVA-20123-99w-5716lm [9.4"x9.4"-15.7']
- UVA-20124-132w-7145lm [9.4"x9.4"-17']

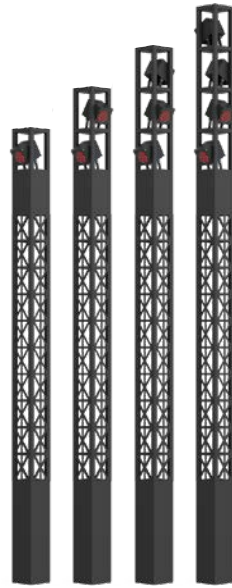

Vancouver 18

- UVA-20131-33w-2858lm [9.4"x9.4"-13.3']
- UVA-20132-66w-4287lm [9.4"x9.4"-14.5']
- UVA-20133-99w-5716lm [9.4"x9.4"-15.7']
- UVA-20134-132w-7145lm [9.4"x9.4"-17']

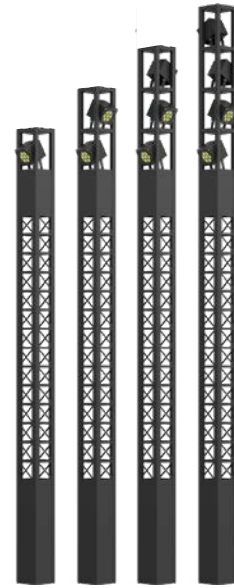

Vancouver 19

- UVA-20141-33w-2858lm [9.4"x9.4"-13.3']
- UVA-20142-66w-4287lm [9.4"x9.4"-14.5']
- UVA-20143-99w-5716lm [9.4"x9.4"-15.7']
- UVA-20144-132w-7145lm [9.4"x9.4"-17']



Vancouver 20

- UVA-20151-33w-1429lm [9.4"x9.4"-12.1']



Vancouver 21

- UVA-20161-33w-1429lm [9.4"x9.4"-12.1']



Vancouver 22

- UVA-20171-33w-1429lm [9.4"x9.4"-12.1']



Vancouver 23

- UVA-20181-33w-1429lm [9.4"x9.4"-12.1']



Vancouver 24

- UVA-30001-8w-331lm [6.3"x6.3"-15.7"]



Vancouver 25

- UVA-30011-21w-570lm [6.3"x6.3"-23.6"]



Vancouver 26

- UVA-30012-21w-490lm [6.3"x6.3"-23.6"]



Vancouver 27

- UVA-30013-21w-740lm [6.3"x6.3"-23.6"]



Vancouver 28

- UVA-30021-39w-1336lm [9.4"x9.4"-39.3']
- UVA-30031-33w RGBW-429lm [9.4"x9.4"-39.3']



Vancouver 29

- UVA-30022-39w-1167lm [9.4"x9.4"-39.3']
- UVA-30032-33w RGBW-1158lm [9.4"x9.4"-39.3']



Vancouver 30

- UVA-30023-39w-1670lm [9.4"x9.4"-39.3']
- UVA-30033-33w RGBW-439lm [9.4"x9.4"-39.3']



Vancouver 31

• UVA-10101-7w-200lm [4.7' x 4.7' - 23.6"]



Vancouver 33

• UVA-10051-15w-1083lm [6.3' x 6.3' - 39.3"]



Vancouver 34

• UVA-10061-21w-1571lm [9.4' x 9.4' - 39.3"]



Vancouver 35

• UVA-10071-21w-1571lm [9.4' x 9.4' - 39.3"]



Vancouver 36

• UVA-10072-21w-1571lm [9.4' x 9.4' - 39.3"]



Vancouver 37

• UVA-10073-21w-1571lm [9.4' x 9.4' - 39.3"]



Vancouver 38

• UVA-10141-8w-95lm [4.7' x 4.7' - 23.6"]



Vancouver 39

• UVA-10151-15w-418lm [6.3' x 6.3' - 39.3"]



Vancouver 40

• UVA-10161-21w-635lm [9.4' x 9.4' - 39.3"]



Vancouver 41

• UVA-20191-20w-1326lm [6.3' x 6.3' - 9.8"]



Vancouver 42

• UVA-20201-40w-2969lm [9.4' x 9.4' - 14.7"]



Vancouver 43

• UVA-20211-39/21w-2781/1688lm [9.4'x9.4"-13.3"]



Vancouver 44

• UVA-20212-39/2x21w-2781/2x1688lm [9.4'x9.4"-14.5"]



Vancouver 45

• UVA-20213-39/3x21w-2781/3x1688lm [9.4'x9.4"-15.7"]



Vancouver 46

• UVA-20221-39/21w-4469/1688lm [9.4'x9.4"-13.3"]



Vancouver 47

• UVA-20221-39/2x21w-4469/2x1688lm [9.4'x9.4'-14.5']



Vancouver 48

• UVA-20223-39/3x21w-4469/3x1688lm [9.4'x9.4'-15.7']



Vancouver 49

• UVA-20231-39/21w-2781/1688lm [9.4'x9.4'-13.3']



Vancouver 50

• UVA-20232-39/2x21w-2781/2x1688lm [9.4'x9.4'-14.5']



Vancouver 51

• UVA-20233-39/2x21w-2781/2x1688lm [9.4'x9.4'-15.7']



Vancouver 52

• UVA-20241-40w-2781lm [9.4'x9.4'-12']



Vancouver 53

• UVA-20242-40w-2781lm [9.4'x9.4'-12']

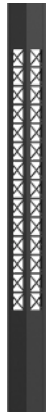

Vancouver 54

• UVA-20243-40w-2781lm [9.4'x9.4'-12']



Vancouver 55

• UVA-20251-21w-710lm [6.3'x6.3'-9.8']



Vancouver 56

• UVA-20261-40w-1485lm [9.4'x9.4'-14.7']

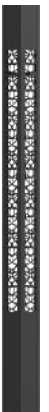

Vancouver 60

• UVA-20281-76w-4140lm [9.4'x9.4'-12']



Vancouver 61

• UVA-20282-76w-4140lm [9.4'x9.4'-12']



Vancouver 62

• UVA-20283-76w-4140lm [9.4'x9.4'-12']



Vancouver 63

• UVA-70021-13w-437lm [6.3'x6.3'-15.7']



Vancouver 64

• UVA-70031-20w-1362lm [9.4'x9.4'-15.7']



Vancouver 65

• UVA-70041-8w-165lm [6.3'x6.3'-15.7']



Vancouver 66

• UVA-70051-21w-410lm [9.4'x9.4'-15.7']



Vancouver 67

• UVA-30041-20w-1326lm [6.3'x6.3'-23.6']



Vancouver 68

• UVA-30042-20w-1326lm [6.3'x6.3'-23.6']



Vancouver 69

• UVA-30043-20w-1326lm [6.3'x6.3'-23.6']



Vancouver 70

• UVA-30051-40w-2781lm [9.4'x9.4'-39.3']



Vancouver 71

• UVA-30052-40w-2781lm [9.4'x9.4'-39.3']



Vancouver 72

• UVA-30053-40w-2781lm [9.4'x9.4'-39.3']