

FS-USAT-90001-RGBW

Santander Post Top



48w LED
2719 Lumens

IP66
Suitable for wet locations

IK08
Impact Resistant [Vandal Resistant]

EPA - Contact Factory

Weight - 28.6 lbs

POLE NOT INCLUDED



Construction

Aluminum

Less than 0.1% copper content – Marine Grade 6060 extruded & LM6 Aluminum High Pressure die casting provides excellent mechanical strength, clean detailed product lines and excellent heat dissipation.

Pre paint

8 step degrease and phosphate process that includes deoxidizing and etching as well as a zinc and nickel phosphate process before product painting.

Memory Retentive -Silicon Gasket

Provided with special injection molded "fit for purpose" long life high temperature memory retentive silicon gaskets. Maintains the gaskets exact profile and seal over years of use and compression.

Thermal management

LM6 Aluminum is used for its excellent mechanical strength and thermal dissipation properties in low and high ambient temperatures. The superior thermal heat sink design by Ligman used in conjunction with the driver, controls thermals below critical temperature range to ensure maximum luminous flux output, as well as providing long LED service life and ensuring less than 10% lumen depreciation at 50,000 hours.

Surge Suppression

Standard 10kv surge suppressor provided with all fixtures.

BUG Rating

Refer to IES files or contact factory

Finishing

All Ligman products go through an extensive finishing process that includes fettling to improve paint adherence.

Paint

UV Stabilized 4.9Mil thick powder coat paint and baked at 200 Deg C.

This process ensures that Ligman products can withstand harsh environments.

Rated for use in natatoriums.

Hardware

Provided Hardware is Marine grade 316 Stainless steel.

Anti Seize Screw Holes

Tapped holes are infused with a special anti seize compound designed to prevent seizure of threaded connections, due to electrolysis from heat, corrosive atmospheres and moisture.

Crystal Clear Low Iron Glass Lens

Provided with tempered, impact resistant crystal clear low iron glass ensuring no green glass tinge.

Optics & LED

Precise optic design provides exceptional light control and precise distribution of light. LED CRI > 80

Lumen - Maintenance Life

L80 /B10 at 50,000 hours (This means that at least 90% of the LED still achieve 80% of their original flux)

Modern, urban post top with open-head design hiding technically precise asymmetric and symmetric streetlight optics.

The Santander Pole Top luminaire combines aesthetics and focused, precision lighting with microVOS™ optics to provide a large range of light distributions and beam patterns.

This product is available with field interchangeable standard Type I, II, III, IV & V (Medium & Wide) distributions, as well as the ability to select specific quadrants within the luminaire and specify different distributions per quadrant.

An example of this could be Type II distributions in 2 quadrants left and Type IV distribution in the remaining quadrants right. This flexibility allows the lighting designer to utilize these optics and specifically place light where needed.

Utilizing this optical flexibility, a single luminaire could produce the same lighting solution and distributions as two separate luminaires on a single pole.

This product range is available in a 126w option, and can be configured for lower customer specific wattages. Contact the factory for more information.

Dark Sky Approved for 2700K & 3000K.



Optional Optical Flexibility

CITY OF FLAGSTAFF & TURTLE FRIENDLY COMPLIANT

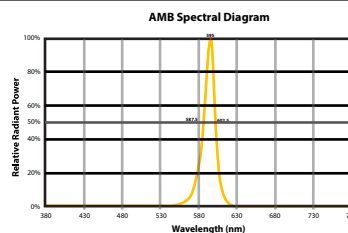

Narrow-Spectrum Amber LEDs

Peak wavelength between 585 & 595 nanometers and a full width of 50% power no greater than 15 nanometers.

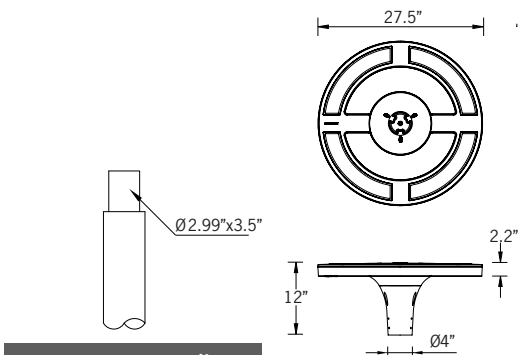

Tenon Detail

Use 4" or 4.5" diameter pole for smooth visual transition with pole top fixture.



Ligman's micro Variable Optical System provides the ability to interchange, mix & rotate optics to provide specific light distributions for optimized spacing and uniformity.

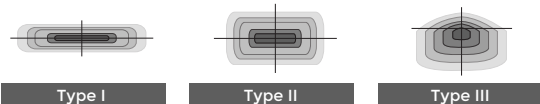

Type I

Type II

Type III



Type IV



Type V

The variable optic system allows for the designer to create hybrid distributions for precise lighting requirements.

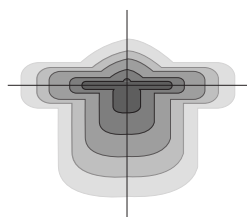

HYBRID
TYPE I & TYPE IV

FS-USAT-90001-RGBW

Santander Post Top



PROJECT		DATE	
----------------	--	-------------	--

QUANTITY		TYPE		NOTE	
-----------------	--	-------------	--	-------------	--

ORDERING EXAMPLE || USAT - 90001 - 48w - T2 - RGBW30 - 02 - 120/277v - Options

USAT-90001					
LAMP	BEAM	RGBW COLOR	FINISH COLOR	VOLTAGE	

48w LED
2719 Lumens

T2 - Type II Distribution
T3 - Type III Distribution
T4 - Type IV Distribution
M - Medium Beam 64°
W - Wide Beam 86°
C - Custom Distribution
SELECT USING DRAWING BELOW

RGBW30 - Warm White 3200K
RGBW40 - Neutral White 4000K
RGBW65 - Cool White 6850K

01 - BLACK RAL 9011
02 - DARK GREY RAL 7043
03 - WHITE RAL 9003
04 - METALLIC SILVER RAL 9006
05 - MATTE SILVER RAL 9006
06 - LIGMAN BRONZE
07 - CUSTOM RAL



120/277v
Other - Specify

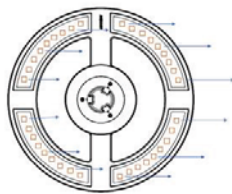
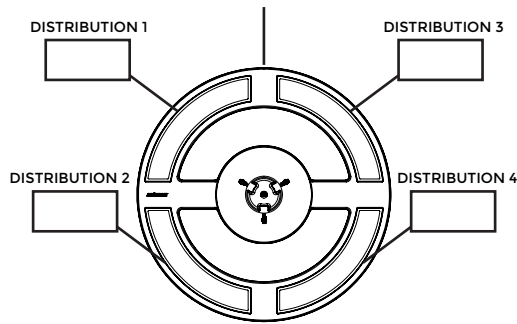

T2 + T4 Right

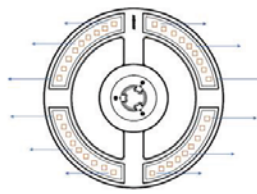

T3 Left + T4 Right

DISTRIBUTION EXAMPLES

--	--	--	--

ADDITIONAL OPTIONS

NAT - Natatorium Rated
DIM - 0-10v Dimming

AMB - Turtle Friendly Amber LED

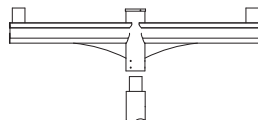
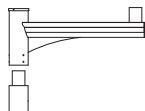
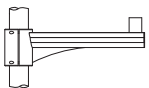

A20176
Aluminum Arm Pole Clamp

A20276
Aluminum Single Arm

A20376
Aluminum Double Arm

