

# UQU-20031

## Quarter Post Top

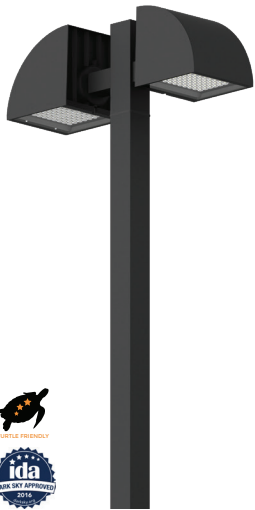

2x54w LED  
2x6387 Lumens

IP65  
Suitable for wet locations

IK08  
Impact Resistant [Vandal Resistant]

EPA - Contact Factory

Weight - 52.2 lbs

**POLE NOT INCLUDED**



### Construction

#### Aluminum

Less than 0.1% copper content – Marine Grade 6060 extruded & LM6 Aluminum High Pressure die casting provides excellent mechanical strength, clean detailed product lines and excellent heat dissipation.

#### Pre paint

8 step degrease and phosphate process that includes deoxidizing and etching as well as a zinc and nickel phosphate process before product painting.

#### Memory Retentive -Silicon Gasket

Provided with special injection molded “fit for purpose” long life high temperature memory retentive silicon gaskets. Maintains the gaskets exact profile and seal over years of use and compression.

#### Thermal management

LM6 Aluminum is used for its excellent mechanical strength and thermal dissipation properties in low and high ambient temperatures. The superior thermal heat sink design by Ligman used in conjunction with the driver, controls thermals below critical temperature range to ensure maximum luminous flux output, as well as providing long LED service life and ensuring less than 10% lumen depreciation at 50,000 hours.

#### Surge Suppression

Standard 10kv surge suppressor provided with all fixtures.

#### BUG Rating

Contact Factory

#### Finishing

All Ligman products go through an extensive finishing process that includes fettling to improve paint adherence.

#### Paint

UV Stabilized 4.9Mil thick powder coat paint and baked at 200 Deg C. This process ensures that Ligman products can withstand harsh environments. Rated for use in natatoriums.

#### Hardware

Provided Hardware is Marine grade 316 Stainless steel.

#### Anti Seize Screw Holes

Tapped holes are infused with a special anti seize compound designed to prevent seizure of threaded connections, due to electrolysis from heat, corrosive atmospheres and moisture.

#### Crystal Clear Low Iron Glass Lens

Provided with tempered, impact resistant crystal clear low iron glass ensuring no green glass tinge.

#### Optics & LED

Precise optic design provides exceptional light control and precise distribution of light. LED CRI > 80

#### Lumen - Maintenance Life

L80 /B10 at 50,000 hours (This means that at least 90% of the LED still achieve 80% of their original flux)

**Modern, contemporary post top**  
**Beautiful modern urban post top in either single or twin arm configuration, offering powerful street lighting and beam performance choices.**

A modern style die-cast aluminum post top decorative quarter cylindrical luminaire with excellent downward light distribution that complies with dark sky requirements. Outstanding visual appeal and precision optical system gives very low glare rating, whilst reducing light pollution. This luminaire is available in two configurations, namely a single or double arm option to suit aesthetic design requirements.

Color temperature 2700K, 3000K, 3500K and 4000K, LED CRI >80 and life time 50,000 Hours. Stainless steel screws. Durable silicone rubber gasket and clear tempered glass. Powder paint with high corrosion resistance with chemical chromatised protection. Integral control gear. Customer specific wattages can be provided, please contact the factory for more information.

Available with a selection of dimmable integral electronic drivers, as well as a provision to install wireless lighting controls to integrate with building management systems. assembly.

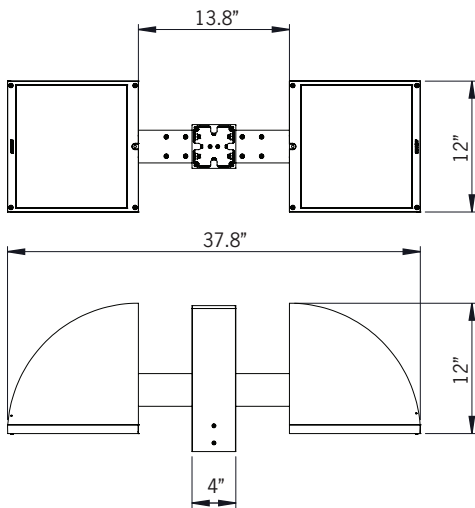

Ligman's micro Variable Optical System provides the ability to interchange, mix & rotate optics to provide specific light distributions for optimized spacing and uniformity.

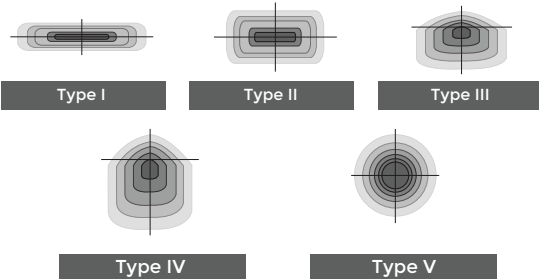

The variable optic system allows for the designer to create hybrid distributions for precise lighting requirements.

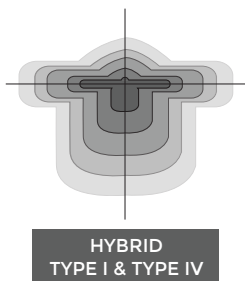

# UQU-20031

## Quarter Post Top



<b>PROJECT</b>		<b>DATE</b>	
----------------	--	-------------	--

<b>QUANTITY</b>		<b>TYPE</b>		<b>NOTE</b>	
-----------------	--	-------------	--	-------------	--

**ORDERING EXAMPLE || UQU - 20031 - 2x54w - T2 - W30 - 02 - 120/277v - Options**

<b>UQU-20031</b>					
<b>LAMP</b>	<b>BEAM</b>	<b>LED COLOR</b>	<b>FINISH COLOR</b>	<b>VOLTAGE</b>	
2x54w LED 2x6387 Lumens	T1 - Type I Distribution T2 - Type II Distribution T3 - Type III Distribution T4 - Type IV Distribution T5 - Type V Distribution ME - Type ME Distribution	W27 - 2700K W30 - 3000K W35 - 3500K W40 - 4000K	01 - BLACK RAL 9011 02 - DARK GREY RAL 7043 03 - WHITE RAL 9003 04 - METALLIC SILVER RAL 9006 05 - MATTE SILVER RAL 9006 06 - LIGMAN BRONZE 07 - CUSTOM RAL	120/277v Other - Specify	

--	--	--

### ADDITIONAL OPTIONS

- DIM - 0-10v Dimming
- NAT - Natatorium Rated
- A20491 - Root Mount Kit
- OS - Occupancy Sensor

#### AMB Turtle Friendly Amber LED

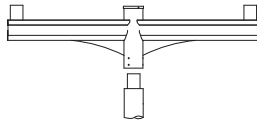
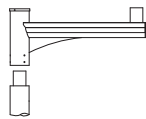
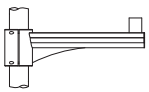

A20176  
Aluminum Arm Pole Clamp

A20276  
Aluminum Single Arm

A20376  
Aluminum Double Arm

### CITY OF FLAGSTAFF & TURTLE FRIENDLY COMPLIANT

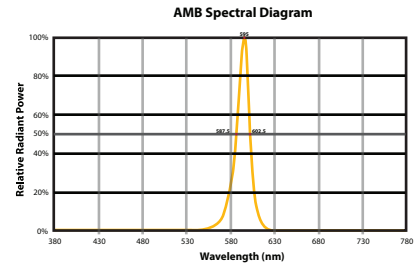

#### Narrow-Spectrum Amber LEDs

Peak wavelength between 585 & 595 nanometers and a full width of 50% power no greater than 15 nanometers.



# Quarter Product Family



Quarter 1

- UQU-31344-37w-512lm
- UQU-31392-53w-7178lm



Quarter 2

- UQU-31401-75w-7178lm
- UQU-31402-103w-13183lm



Quarter 1

- UQU-20001-37w-512lm
- UQU-20002-53w-7171lm
- UQU-20011-2x37w-2x512lm
- UQU-20012-2x53w-7171lm



Quarter 2

- UQU-20021-53w-6955lm
- UQU-20022-75w-10079lm
- UQU-20031-2x53w-2x6955lm
- UQU-20032-2x75w-2x10079lm