

# UQA-50004

## Quantum 1 Small RGBW Floodlight



RGBW

33w LED 1185 Lumens  
IP66 • Suitable For Wet Locations  
IK08 • Impact Resistant (Vandal Resistant)  
Weight 8.1 lbs

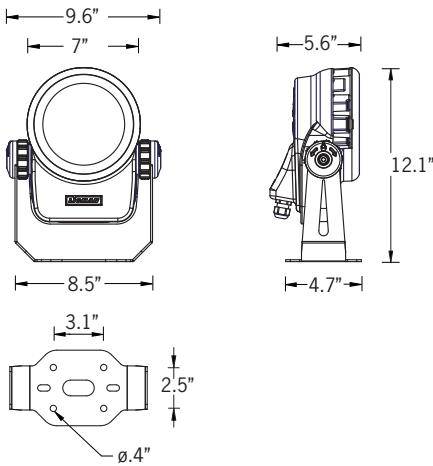

Mounting Detail

### Construction

#### Aluminum

Less than 0.1% copper content – Marine Grade 6060 extruded & LM6 Aluminum High Pressure die casting provides excellent mechanical strength , clean detailed product lines and excellent heat dissipation.

#### Pre paint

8 step degrease and phosphate process that includes deoxidizing and etching as well as a zinc and nickel phosphate process before product painting.

#### Memory Retentive -Silicon Gasket

Provided with special injection molded "fit for purpose" long life high temperature memory retentive silicon gaskets. Maintains the gaskets exact profile and seal over years of use and compression.

#### Thermal management

LM6 Aluminum is used for its excellent mechanical strength and thermal dissipation properties in low and high ambient temperatures. The superior thermal heat sink design by Ligman used in conjunction with the driver, controls thermal below critical temperature range to ensure maximum luminous flux output, as well as providing long LED service life and ensuring less than 10% lumen depreciation at 50,000 hours.

#### Surge Suppression

Standard 10kv surge suppressor provided with all fixtures.

#### BUG Rating

B4 - U5 - G5

#### Finishing

All Ligman products go through an extensive finishing process that includes fettling to improve paint adherence.

#### Paint

UV Stabilized 4.9Mil thick powder coat paint and baked at 200 Deg C. This process ensures that Ligman products can withstand harsh environments. Rated for use in natatoriums.

#### Inspired by Nature Finishes

The Inspired by nature Finishing is a unique system of decorative powder coating. Our metal decoration process can easily transform the appearance of metal or aluminum product into a wood grain finish.

This patented technology enables the simulation of wood grain, and even marble or granite finish through the use of decorative powder coating.

The wood grain finish is so realistic that it's almost undistinguishable from real wood, even from a close visual inspection. The system of coating permeates the entire thickness of the coat and as a result, the coating cannot be removed by normal rubbing, chipping, or scratching.

#### The Coating Process

After pre-treatment the prepared parts are powder coated with a specially formulated polyurethane powder. This powder provides protection against wear, abrasion, impact and corrosion and acts as the relief base color for the finalized metal decoration.

The component is then wrapped with a sheet of non-porous film with the selected decoration pattern printed on it using special high temperature inks.

This printed film transfer is vacuum-sealed to the surface for a complete thermo print and then transferred into a customized oven. The oven transforms the ink into different forms within the paint layer before it becomes solid. Finally, the film is removed, and a vivid timber look on aluminum remains.

Wood grain coating can create beautiful wood-looking products of any sort. There are over 300 combinations of designs currently in use. Wood grains can be made with different colors, designs, etc.

Our powder coatings are certified for indoor and outdoor applications and are backed by a comprehensive warranty. These coatings rise to the highest conceivable standard of performance excellence and design innovation.

#### Added Benefits

- Resistance to salt-acid room, accelerated aging
- Boiling water, lime and condensed water resistant
- Anti-Graffiti, Anti-Slip, Anti-Microbial, Anti-Scratch
- Super durable (UV resistant)
- TGIC free (non-toxic)

#### Hardware

Provided Hardware is Marine grade 316 Stainless steel.

#### Anti-Seize Screw Holes

Tapped holes are infused with a special anti seize compound designed to prevent seizure of threaded connections, due to electrolysis from heat, corrosive atmospheres and moisture.

#### Crystal Clear Low Iron Glass Lens

Provided with tempered, impact resistant crystal clear low iron glass ensuring no green glass tinge.

#### Optics & LED

Precise optic design provides exceptional light control and precise distribution of light.  
LED CRI > 80

#### Lumen - Maintenance Life

L80 /B10 at 50,000 hours (This means that at least 90% of the LED still achieve 80% of their original flux)

**Adjustable surface-mounted technical floodlights. Premium projector solutions with stylish modern design, unique rotary thermal guard and numerous project options.**





Quantum small and medium LED projector range with a modern and smart design. The high pressure die-cast housings have integrated heat sinks, as well as an internal waterproof control gear housing compartment. The mounting arm is attached to a ratcheting tilting adjustment that is lockable once the desired aiming position has been achieved. This mechanism allows for small incremental adjustments for precision aiming.

This fixture has been designed around powerful high performance LEDs and precision optics so that the luminaire can be used to illuminate various applications from building facades to high multi story surfaces and accents.

This luminaire range is available with RGBW dynamic color changing technology or static white LEDs to give the specifier artistic lighting options within the same unified product family.

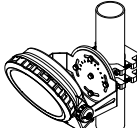
Available in Narrow, Medium, Wide and Elliptical light distribution. RGBW full colours render for each LEDs and static white for Color temperature 2700K, 3000K, 3500K and 4000K. Single cable gland entry for wiring is standard. Optional anti-glare louvers are available as an option. Consult factory for available configurations.

### Additional Options (Consult Factory For Pricing)

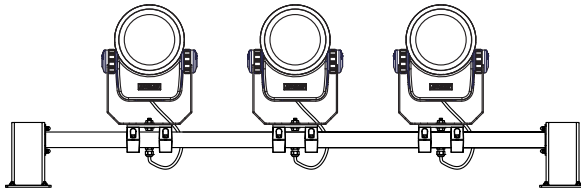
			
AGL Anti Glare Louver	PC-X Pole Clamp 4-5.5"	A53631 Visor	PKM Pedestal Knuckle Mount
			
A53731 Anti Glare Hood	A51614 Linear Spread Lens		
			
RM Rail Mount Option (Number of Floods May Be Specified)			

# UQA-50004

Quantum 1 Small RGBW Floodlight

<b>PROJECT</b>		<b>DATE</b>	
----------------	--	-------------	--

<b>QUANTITY</b>		<b>TYPE</b>		<b>NOTE</b>	
-----------------	--	-------------	--	-------------	--

ORDERING EXAMPLE || UQA - 50004 - 33w LED - N - RGBW30 - 02 - 120/277v

<b>UQA-50004</b>					
<b>LAMP</b>	<b>BEAM</b>	<b>RGBW COLOR</b>	<b>FINISH COLOR</b>	<b>VOLTAGE</b>	
33w LED 1185 Lumens	N - Narrow 21° M - Medium 35° E - Elliptical 26° x 48°	RGBW30 - Warm White 3200K RGBW40 - Neutral White 4000K RGBW65 - Cool White 6850K	01 - BLACK RAL 9011 02 - DARK GREY RAL 7043 03 - WHITE RAL 9003 04 - METALLIC SILVER RAL 9006 05 - MATTE SILVER RAL 9006 06 - LIGMAN BRONZE 07 - CUSTOM RAL	120/277v Other - Specify	

--	--	--	--

## ADDITIONAL OPTIONS

F - Frosted Lens

A53631 - Visor

### POLE CLAMPS

NAT - Natatorium Rated

A51614 Linear Spread Lens

PC4 - Pole Clamp 4" Dia

AGL - Anti Glare Louvre

A53731 - Anti Glare Hood

PC45 - Pole Clamp 4.5" Dia

RM - Rail Mounted  
(Specify # of Floods)

PKM - Pedestal Knuckle Mount

PC5 - Pole Clamp 5" Dia

PC55 - Pole Clamp 5.5" Dia

### INSPIRED BY NATURE FINISHES

- SW01 - OAK FINISH
- SW02 - WALNUT FINISH
- SW03 - PINE FINISH
- DF - DOUGLAS FIR FINISH
- CW - CHERRY WOOD FINISH
- NW - NATIONAL WALNUT FINISH
- SU01 - CONCRETE FINISH
- SU02 - SOFTSCAPE FINISH
- SU03 - STONE FINISH
- SU04 - CORTEN FINISH

THERE IS AN ADDITIONAL COST FOR THESE FINISHES



## More Custom Finishes Available Upon Request

Consult factory for pricing and lead times



# Quantum Product Family



- UQA-50001-42w-3634lm
- UQA-50003-32w-2790lm
- UQA-50004-33w RGBW-1432lm



- UQA-50011-104w-10611lm
- UQA-50013-76w-7175lm
- UQA-50015-77w RGBW-4296lm

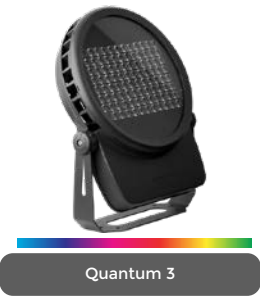

- UQA-50021-269w-27436lm
- UQA-50022-191w RGBW-12213lm



- UQA-21001-3x42w-3x3634lm
- UQA-21003-3x32w-3x3250lm
- UQA-21004-3x33w RGBW-3x1185lm
- UQA-21011-6x42w-6x3634lm
- UQA-21013-6x32w-6x3250lm
- UQA-21014-6x33w RGBW-6x1185lm



- UQA-21021-104w-10611lm
- UQA-21023-76w-7175lm
- UQA-21024-84w-8031lm
- UQA-21031-2x104w-2x10611lm
- UQA-21033-2x76w-2x7175lm
- UQA-21034-2x84w-2x8031lm



- UQA-21025-77w-4296lm
- UQA-21035-2x77w-2x4296lm