

UFOR-10011

Forrey 1 Bollard No Lens



Construction

Aluminum
Less than 0.1% copper content – Marine Grade 6060 extruded & LM6 Aluminum High Pressure die casting provides excellent mechanical strength, clean detailed product lines and excellent heat dissipation.

Pre paint
8 step degrease and phosphate process that includes deoxidizing and etching as well as a zinc and nickel phosphate process before product painting.

Memory Retentive -Silicon Gasket
Provided with special injection molded "fit for purpose" long life high temperature memory retentive silicon gaskets. Maintains the gaskets exact profile and seal over years of use and compression.

Thermal management
LM6 Aluminum is used for its excellent mechanical strength and thermal dissipation properties in low and high ambient temperatures. The superior thermal heat sink design by Ligman used in conjunction with the driver, controls thermals below critical temperature range to ensure maximum luminous flux output, as well as providing long LED service life and ensuring less than 10% lumen depreciation at 50,000 hours.

Surge Suppression
Standard 10kv surge suppressor provided with all fixtures.

BUG Rating
B2 - U0 - G1 [T3/W30,T5/W30]
B2 - U0 - G2 [T2/W30/W40,T3/W40,T4/W30/W40]
B3 - U0 - G1 [T5/W40]

Finishing
All Ligman products go through an extensive finishing process that includes fettling to improve paint adherence.

Paint
UV Stabilized 4.9Mil thick powder coat paint and baked at 200 Deg C. This process ensures that Ligman products can withstand harsh environments. Rated for use in natatoriums.

MicroPRIM Finishes
MicroPRIM is Ligman's trade marked decorative powder coating technology that permanently infuses colors, patterns, or imagery directly into the surface of luminaires and poles while providing protections that standard powder coating does not offer.

MicroPRIM finishes include nature-inspired wood grains and stone aesthetics, material-inspired finishes such as brushed metal, concrete, and carbon fiber, Solid colors in Ligman standard colors, as well as any RAL or Pantone color, Decorative patterns, custom imagery and more.

Coating and Infusion Process

Metal components are pre-treated and powder coated with a proprietary polyurethane-based coating engineered for outdoor architectural use. Decorative patterns or imagery are then permanently infused into the cured powder coat through a heat-based process, creating a durable, integrated finish.

Performance and Validation

MicroPRIM finishes are suitable for indoor and outdoor applications and meet AAMA2605 architectural coating requirements. Performance is validated through laboratory and real-world testing to ASTM standards for UV exposure, adhesion, abrasion, impact, salt spray, chemical resistance, and graffiti resistance.

All MicroPRIM finishes are backed by Ligman's 10-year warranty.

Key Performance Attributes
•Anti-graffiti resistance
•UV and weather resistance
•Scratch and abrasion resistance
•Natatorium Rated for installation in corrosive environments

Hardware
Provided Hardware is Marine grade 316 Stainless steel.

Anti Seize Screw Holes
Tapped holes are infused with a special anti seize compound designed to prevent seizure of threaded connections, due to electrolysis from heat, corrosive atmospheres and moisture.

Optics & LED
Precise optic design provides exceptional light control and precise distribution of light.
LED CRI > 80

Lumen - Maintenance Life
L80 /B10 at 50,000 hours (This means that at least 90% of the LED still achieve 80% of their original flux)

48w COB 4755 Lumens
IP65 · Suitable For Wet Locations
IK08 · Impact Resistant (Vandal Resistant)
Weight 23.1 lbs

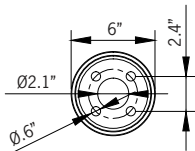
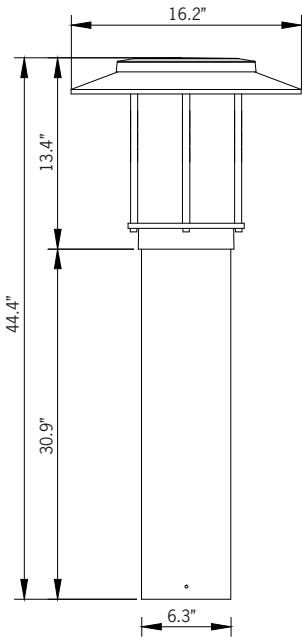

Mounting Detail

High efficiency meets the classic for factor. Complete range of decorative lighting solutions, offering multiple beam distributions and superior efficacies.

A decorative range of bollard luminaires, designed to complement the Forrey pendant, post top and wall mount with options of having no lens or a high impact UV stabilized opal lens. This decorative lantern provides a symmetrical light distribution using high output COB LED.

Color temperature 2700K, 3000K, 3500K and 4000K, LED CRI >80 and life time 50,000 Hours. High pressure die-cast marine grade LM6 aluminum body that is pre-treated with a nickel and zinc phosphate and then powder coated with a 4.9mil thick paint finish ensuring high corrosion resistance. Marine grade 316 stainless steel fasteners.

To meet International Dark Sky criteria, 3000k or warmer LEDs must be selected.

For Opal Lens, see UFOR-10031

Security Bollard:

This product can be modified with optional Security Bollard cores. Ligman has two security bollard options designed to deter unauthorized vehicular access in restricted areas.

Ligman's Standard Security Bollards [SB] are structurally engineered and simulated to meet the performance criteria of a typical traffic-rated bollard system, which corresponds to a 5,000 lb vehicle impact up to 30mph with less than 4ft of penetration.

Ligman's Reinforced Security Bollards [RSB] are structurally engineered for impact resistance and simulated to meet the performance criteria of ASTM F2656 M30 P1 (formerly known as K4), which corresponds to a 15,000 lb vehicle impact up to 30mph with less than 3.3 ft of penetration. These bollards are not certified as crash-rated.

Please refer to the product installation sheet for additional requirements and installation guidelines.

Additional Options (Consult Factory For Pricing)

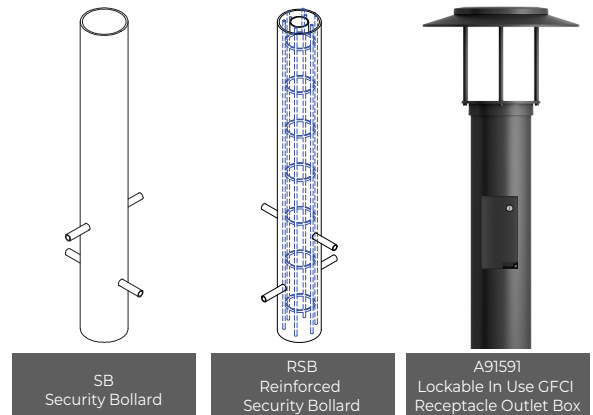

SB Security Bollard

RSB Reinforced Security Bollard

A91591 Lockable In Use GFCI Receptacle Outlet Box

UFOR-10011

Forrey 1 Bollard No Lens

PROJECT		DATE	
---------	--	------	--

QUANTITY		TYPE		NOTE	
----------	--	------	--	------	--

ORDERING EXAMPLE || UFOR - 10011 - 48w - T3 - W30 - 02 - 120/277v - Options

UFOR-10011					
LAMP	BEAM	LED COLOR	FINISH COLOR	VOLTAGE	

48w COB
4755 Lumens

T2 - Type II Distribution
T3 - Type III Distribution
T4 - Type IV Distribution
T5 - Type V Distribution

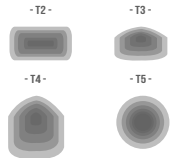

W27 - 2700K
W30 - 3000K
W35 - 3500K
W40 - 4000K

01 - BLACK RAL 9011
02 - DARK GREY RAL 7043
03 - WHITE RAL 9003
04 - METALLIC SILVER RAL 9006
05 - MATTE SILVER RAL 9006
06 - LIGMAN BRONZE
07 - CUSTOM RAL



120/277v

THERE IS AN ADDITIONAL COST FOR CUSTOM COLORS



A91591
Lockable In Use GFCI
Receptacle Outlet Box

ADDITIONAL OPTIONS				

- DIM - 0-10v Dimming
- NAT - Natatorium Rated
- HGT - Custom Bollard Height
- C - Clear Lens
- SB - Security Bollard
- RSB - Reinforced Security Bollard
- A91591 - Lockable In Use GFCI Receptacle Outlet Box

More Custom Finishes Available Upon Request

Consult factory for pricing and lead times

MicroPRIM FINISHES

- SW01 - OAK FINISH
- SW02 - WALNUT FINISH
- SW03 - PINE FINISH
- DF - DOUGLAS FIR FINISH
- CW - CHERRY WOOD FINISH
- NW - NATIONAL WALNUT FINISH
- SU01 - CONCRETE FINISH
- SU02 - SOFTSCAPE FINISH
- SU03 - STONE FINISH
- SU04 - CORTEN FINISH
- CSM - Custom Image/Pattern

MicroPRIM FINISHES

- MP - MAPLE FINISH
- MHG - MAHOGANY FINISH
- BH - BEECH FINISH
- CN - CHESTNUT FINISH
- WMBL - WHITE MARBLE FINISH
- MBL - MARBLE FINISH
- GRNT - GRANITE FINISH
- BGD - BRUSHED GOLD FINISH
- BBRZ - BRUSHED BRONZE FINISH
- CAMO - CAMOUFLAGE FINISH

- MP01 - MicroPRIM RAL 9011 Black (Glossy)
- MP02 - MicroPRIM RAL 7043 Dark Grey (Glossy)
- MP03 - MicroPRIM RAL 9003 White (Glossy)
- MP04 - MicroPRIM RAL 9006 Metallic Silver (Glossy)
- MP05 - MicroPRIM RAL 9006 Matte Silver (Matte/Textured)
- MP06 - MicroPRIM Ligman Bronze (Glossy)
- MP07 - MicroPRIM Custom Color (Glossy)



Example: MicroPRIM Finish



Forrey Product Family



Forrey 1 Ø6.3

- UFOR-10001-48w COB-4755lm-32.4"
- UFOR-10011-48w COB-4755lm-42.8"
- UFOR-10021-50w LED-4340lm-32.4"
- UFOR-10031-50w LED-4340lm-42.8"



Forrey 2 Ø6.3"

- UFOR-10002-48w COB-3527lm-32.4"
- UFOR-10012-48w COB-3527lm-42.8"
- UFOR-10022-50w LED-3361lm-32.4"
- UFOR-10032-50w LED-3361lm-42.8"



Forrey 3 Ø7.3"

- UFOR-10081-51w COB-4755lm-34.3"
- UFOR-10091-48w COB-4755lm-46.3"
- UFOR-10101-50w LED-4340lm-34.3"
- UFOR-10111-50w LED-4340lm-46.3"



Forrey 4 Ø7.3"

- UFOR-10082-48w COB-3527lm-34.3"
- UFOR-10092-48w COB-3527lm-34.3"
- UFOR-10102-50w LED-3361lm-34.3"
- UFOR-10112-50w LED-3361lm-34.3"



Forrey 5 Ø6.3

- UFOR-10041-48w COB-4780lm-32.4"
- UFOR-10051-48w COB-4780lm-42.8"
- UFOR-10061-50w LED-4556lm-32.4"
- UFOR-10071-50w LED-4556lm-42.8"

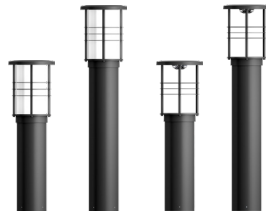

Forrey 6 Ø6.3

- UFOR-10042-48w COB-3711lm-42.8"
- UFOR-10062-50w LED-3526lm-42.8"
- UFOR-10052-48w COB-3711lm-42.8"
- UFOR-10072-50w LED-3526lm-42.8"

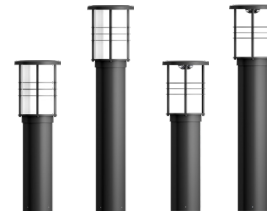

Forrey 8 Ø7.3"

- UFOR-10122-48w COB-3711lm-46.3"
- UFOR-10132-48w COB-3711lm-46.3"
- UFOR-10142-50w LED-3526lm-34.3"
- UFOR-10152-50w LED-3526lm-46.3"



Forrey 9 Ø26"

- UFOR-20001-48w COB-4813m
- UFOR-20011-50w LED-4197lm



Forrey 10 Ø26"

- UFOR-20002-48w COB-3749m
- UFOR-20012-50w LED-3275lm



Forrey 11 Ø34.6"

- UFOR-20041-70w COB-7522lm
- UFOR-20051-60w LED-4553lm

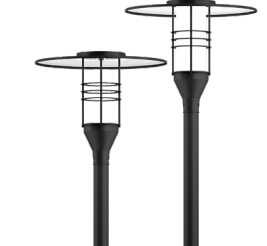

Forrey 12 Ø34.6"

- UFOR-20042-70w COB-6603lm
- UFOR-20052-60w LED-4053lm



Forrey 13 Ø12.5"

- UFOR-20021-48w COB-4780lm
- UFOR-20031-50w LED-4556lm



Forrey 14 Ø9.8"

- UFOR-20022-48w COB-3711lm
- UFOR-20032-50w LED-3526lm



Forrey 15 Ø12.5"

- UFOR-20061-70w COB-8415lm
- UFOR-20071-60w LED-4553lm



Forrey 16 Ø12.5"

- UFOR-20061-70w COB-8415lm
- UFOR-20071-60w LED-4553lm



Forrey 17 Ø26"

- UFOR-30001-48w COB-4813lm
- UFOR-30011-50w LED-4197lm



Forrey 18 Ø26"

- UFOR-30002-48w COB-3749lm
- UFOR-30012-50w LED-3275lm



Forrey 19 Ø34.6"

- UFOR-30041-70w COB-7522lm
- UFOR-30051-60w LED-4553lm



Forrey 20 Ø34.6"

- UFOR-30042-70w COB-6603lm
- UFOR-30052-60w LED-4053lm



Forrey 21 Ø9.8"

- UFOR-30021-48w COB-4780lm
- UFOR-30031-50w LED-4556lm



Forrey 22 Ø6.3

- UFOR-30022-48w COB-3711lm
- UFOR-30032-50w LED-3526lm



Forrey 23 Ø12.5"

- UFOR-30061-70w COB-8415lm
- UFOR-30071-60w LED-4553lm



Forrey 24 Ø12.5"

- UFOR-30062-70w COB-6603lm
- UFOR-30072-60w LED-4053lm



Forrey 25 Ø26"

- UFOR-95001-48w COB-4813lm
- UFOR-95011-50w LED-4197lm



Forrey 26 Ø6.3

- UFOR-95002-48w COB-3749lm
- UFOR-95012-50w LED-3275lm



Forrey 27 Ø34.6"

- UFOR-95041-70w COB-7522lm
- UFOR-95051-60w LED-4553lm



Forrey 28 Ø34.6"

- UFOR-95042-70w COB-6603lm
- UFOR-95052-60w LED-4053lm



Forrey 29 Ø9.8"/8.8"

- UFOR-95021-48w COB-4780lm
- UFOR-95031-50w LED-4556lm



Forrey 30 Ø9.8"/8.8"

- UFOR-95022-48w COB-3711lm
- UFOR-95032-50w LED-3526lm



Forrey 31 Ø12.5"/10.5"

- UFOR-95061-70w COB-8415m
- UFOR-95071-60w LED-4553lm



Forrey 32 Ø12.5"/10.5"

- UFOR-95062-70w COB-6603m
- UFOR-95072-60w LED-4053lm



Forrey 33 Ø20"

- UFOR-30081-50w LED-4813lm



Forrey 34 Ø20"

- UFOR-30082-50w LED-3749lm



Forrey 35 Ø20"

- UFOR-30091-48w LED-4197lm



Forrey 36 Ø20"

- UFOR-30092-48w LED-3275lm