

APD-RSA-5018-18'-5" DIA - .188"-WOODLAND

Round Straight Aluminum Pole

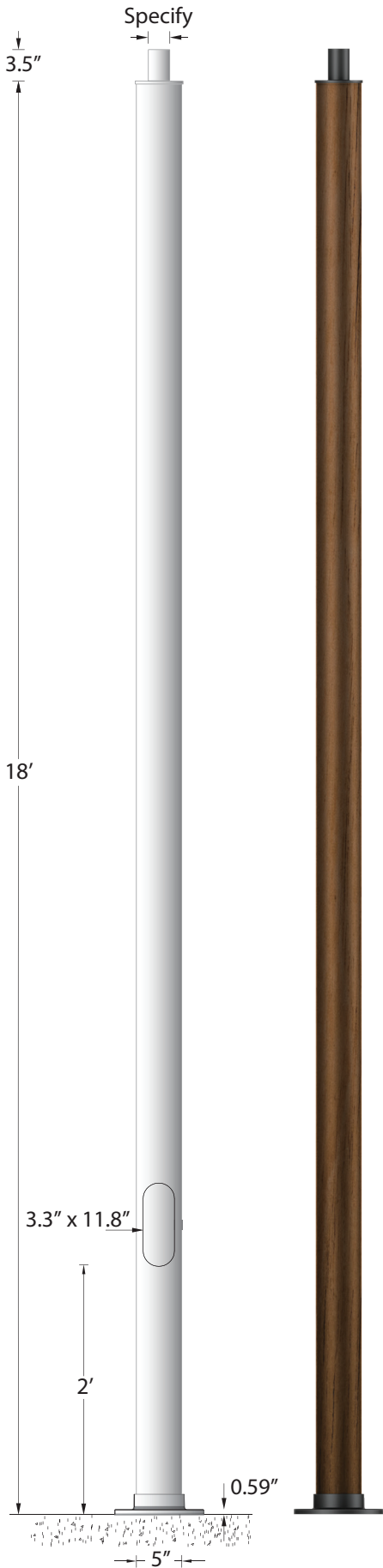

Tenon Post Top

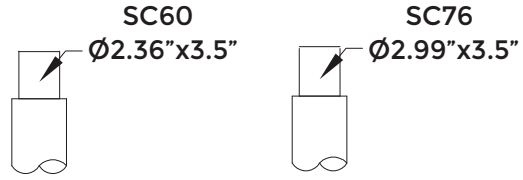

Physical Data

Pole Height: 18'
 Pole Diameter: 5"
 Thickness: 0.188"
 Weight: 67.2 lbs

Pole Mount Install Notes

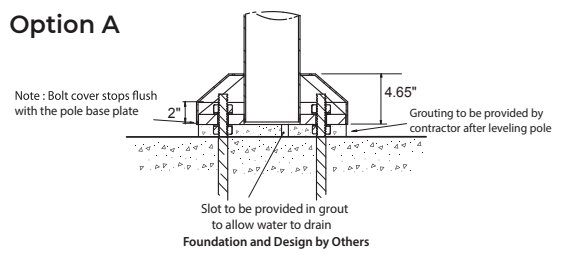

Anchor Bolt

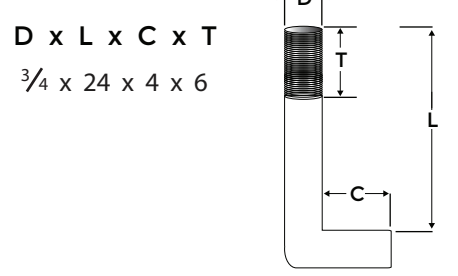

Option B

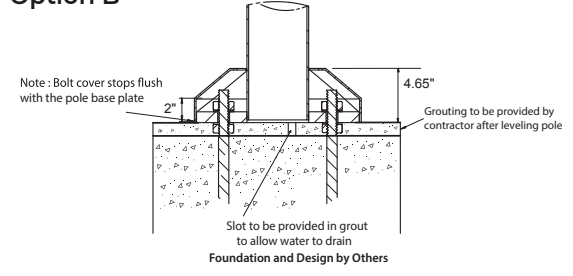

Bolt Projection

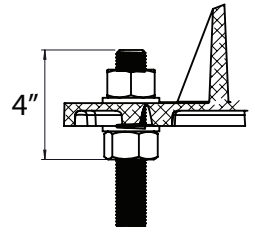

Mounting Base

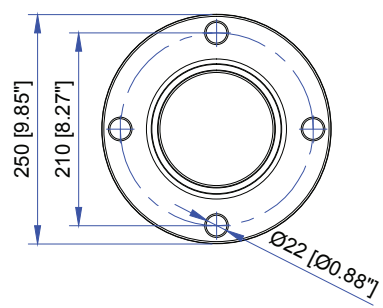

Die-Cast Base Cover



Maximum EPA

MPH	90	100	110	120	130
EPA	9.2	6.8	6.2	5.1	4.2

Wind Load Map



Ligman Lighting USA reserves the right to change specifications without prior notice, please contact factory for latest information. Due to the continual improvements in LED technology data and components may change without notice.

APD-RSA-5018-18'-5" DIA - .188"-WOODLAND

Round Straight Aluminum Pole



PROJECT	<input type="text"/>	DATE	<input type="text"/>
QUANTITY	<input type="text"/>	TYPE	<input type="text"/>
		NOTE	<input type="text"/>

ORDERING EXAMPLE || APD-RSA-5018-18'-5" DIA .188"-SC60-02-Options

<input type="text"/>	<input type="text"/>
TENON	FINISH COLOR

SC60 - 2.36" x 3.5" Tenon
 SC76 - 2.99" x 3.5" Tenon

DF - DOUGLAS FIR FINISH
 CW - CHERRY WOOD FINISH
 NW - NATIONAL WALNUT FINISH



The Ligman faux timber sets the standard for the latest innovations in timber finish on aluminum worldwide. The timber look on aluminum is both gorgeous and adaptable to a variety of uses from poles, bollards and sconces.

Ligman utilizes innovations in faux timber on aluminum technology to create stunning materials for both commercial and residential applications. The process begins by pre-treating raw aluminum to develop light layers of amorphous oxide. Non-hazardous powder paint is applied by electrostatic guns to create a 2.5 mils layer of coating.

A printed film transfer is vacuum sealed to the surface for a complete thermo print and then transferred into a customized oven. The oven transforms the ink into different forms within the paint layer before it becomes solid. Finally, the film is removed and provides a vivid timber look on the aluminum.

Faux timber on aluminum creates a realistic and durable solution to traditional building options while retaining the stunning appearance of timber. Businesses and contractors will appreciate the light-weight strength of timber finish on aluminum that saves on labour and transportation costs.

- This coating protects the aluminum from weather, corrosion, humidity, light and is fire-retardant.
- Timber finish powder coating creates a superior, high-definition coloration that does not fade compared to conventional timber.
- The process operates under precise standards, garnering certificates from the American Architectural Manufacturers Association (AAMA) and acknowledged by the European Laboratory and Research Organization.
- This product is available in a wide array of stunning colors and patterns to create a custom look. (Contact factory for more details)

This environmentally conscious process saves extensive quantities of timber.

Ligman recognizes how our environment and natural resources are fragile and precious. So as an integral part of our Corporate Social Responsibility company policy, we strive to always minimize our environmental impact as well as offer truly long-term sustainable installations to our clients. Ligman's products are designed to last and remain stable in every region and throughout all the variable seasonal environmental conditions.

Offering our special baked transfer-wood finishes on our all our exterior ranges means not only can we offer dozens and dozens of specific different wood types to match any landscape design, but we can do this on a whole family of matching columns, bollards, wall and floodlights and critically that the specified finish is future proof; guaranteed against any cracking and fading and resistant to degradation by Ultraviolet Radiation. In contrast a natural resource such as cut-down wood will always fade and deteriorate over time in exterior environments and is extremely limited in applications.

<input type="text"/>	<input type="text"/>	<input type="text"/>
----------------------	----------------------	----------------------

ADDITIONAL OPTIONS - CONSULT FACTORY FOR PRICING

A20581 - Single Banner Arm
 A20681 - Double Banner Arm
 GFCI - GFCI Box

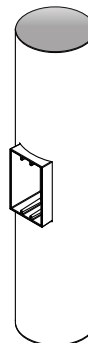
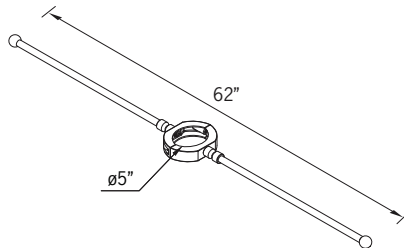
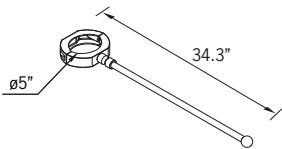

A20581
Single Banner Arm

A20681
Double Banner Arm

GFCI
GFCI Box

Banner arms are designed with a safety break-away at the clamp with an internal safety wire that prevents the arm from falling to the ground.

Not to scale template:

This drawing is being furnished for reference dimensions only and cannot be used as a template to set anchor bolts. Since it is "not to scale" Ligman accepts no responsibility for its intended use. Refer to site plans and specification before installing any anchor bolts.

• Contact Ligman Lighting USA for bolt template prior to pouring anchor bolts.