

UVK-30022

Vekter 9 Medium Adjustable Arm

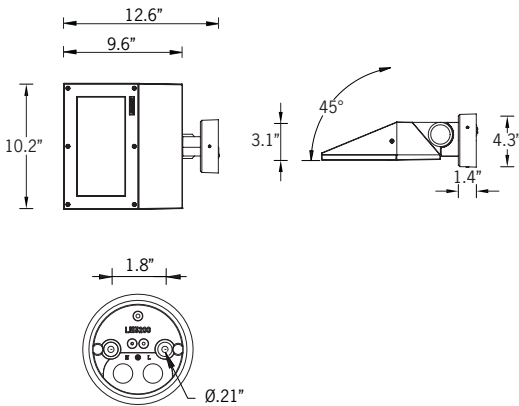

28w LED 3308 Lumens
IP65 • Suitable For Wet Locations
IK08 • Impact Resistant (Vandal Resistant)
Weight 12.1 lbs



Mounting Detail



Ligman's micro Variable Optical System provides the ability to interchange, mix & rotate optics to provide specific light distributions for optimized spacing and uniformity.

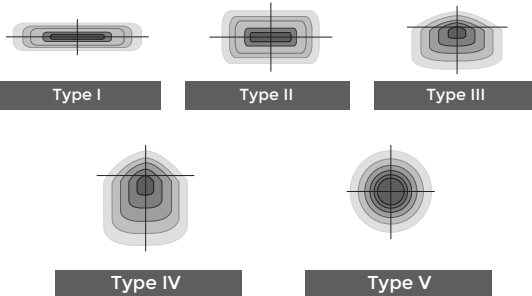

The variable optic system allows for the designer to create hybrid distributions for precise lighting requirements.

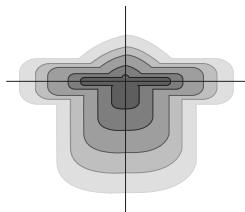

HYBRID
TYPE I & TYPE IV

Construction

Aluminum.
 Less than 0.1% copper content - Marine Grade 6060 extruded & LM6 Aluminum High Pressure die casting provides excellent mechanical strength, clean detailed product lines and excellent heat dissipation.

Pre paint
 8 step degrease and phosphate process that includes deoxidizing and etching as well as a zinc and nickel phosphate process before product painting.

Memory Retentive -Silicon Gasket
 Provided with special injection molded "fit for purpose" long life high temperature memory retentive silicon gaskets. Maintains the gaskets exact profile and seal over years of use and compression.

Thermal management
 LM6 Aluminum is used for its excellent mechanical strength and thermal dissipation properties in low and high ambient temperatures. The superior thermal heat sink design by Ligman used in conjunction with the driver, controls thermals below critical temperature range to ensure maximum luminous flux output, as well as providing long LED service life and ensuring less than 10% lumen depreciation at 50,000 hours.

Surge Suppression
 Standard 10kv surge suppressor provided with all fixtures.

BUG Rating
 B2 - U0 - G0

Finishing.
 All Ligman products go through an extensive finishing process that includes fettling to improve paint adherence.

Paint
 UV Stabilized 4.9Mil thick powder coat paint and baked at 200 Deg C. This process ensures that Ligman products can withstand harsh environments. Rated for use in natatoriums.

Inspired by Nature Finishes
 The Inspired by nature Finishing is a unique system of decorative powder coating. Our metal decoration process can easily transform the appearance of metal or aluminum product into a wood grain finish.

This patented technology enables the simulation of wood grain, and even marble or granite finish through the use of decorative powder coating.

The wood grain finish is so realistic that it's almost undistinguishable from real wood, even from a close visual inspection. The system of coating permeates the entire thickness of the coat and as a result, the coating cannot be removed by normal rubbing, chipping, or scratching.

The Coating Process
 After pre-treatment the prepared parts are powder coated with a specially formulated polyurethane powder. This powder provides protection against wear, abrasion, impact and corrosion and acts as the relief base color for the finalized metal decoration.

The component is then wrapped with a sheet of non-porous film with the selected decoration pattern printed on it using special high temperature inks.

This printed film transfer is vacuum-sealed to the surface for a complete thermo print and then transferred into a customized oven. The oven transforms the ink into different forms within the paint layer before it becomes solid. Finally, the film is removed, and a vivid timber look on aluminum remains.

Wood grain coating can create beautiful wood-looking products of any sort. There are over 300 combinations of designs currently in use. Wood grains can be made with different colors, designs, etc.

Our powder coatings are certified for indoor and outdoor applications and are backed by a comprehensive warranty. These coatings rise to the highest conceivable standard of performance excellence and design innovation.

- Added Benefits**
- Resistance to salt-acid room, accelerated aging
 - Boiling water, lime and condensed water resistant
 - Anti-Graffiti, Anti-Slip, Anti-Microbial, Anti-Scratch
 - Super durable (UV resistant)
 - TGIC free (non-toxic)

Hardware
 Provided Hardware is Marine grade 316 Stainless steel.

Anti Seize Screw Holes
 Tapped holes are infused with a special anti seize compound designed to prevent seizure of threaded connections, due to electrolysis from heat, corrosive atmospheres and moisture.

Crystal Clear Low Iron Glass Lens
 Provided with tempered, impact resistant crystal clear low iron glass ensuring no green glass tinge.

Optics & LED
 Precise optic design provides exceptional light control and precise distribution of light. LED CRI > 80

Lumen - Maintenance Life
 L80 /B10 at 50,000 hours (This means that at least 90% of the LED still achieve 80% of their original flux)

Flexible wall-mounted floodlighting and area luminaires. Sleek, angular, technical and powerful professional lighting solutions.

A wedge shaped range of small profile wall mounted luminaires, with no visible external hardware for use in uplight or downlight applications. This product is provided with a range of high powered LEDs with a selection of optics.

The Vekter is unique as it is available with Type II, III, IV & V light distribution options that facilitates wider spacing and even light distribution between the light fixtures. Wide spacings of up to 40' on center can be achieved using a type II optic with uniformity that complies to path of egress requirements. This provides higher energy saving and reduced installation costs. The Vekter can be manufactured using different type beam optics to achieve custom distribution, e.g using type II and type IV optics inside the same luminaire.

Integral electronic control gear is housed in a special waterproof box that can be detached from the optical chamber for easy installation. Mounting plate for 3" and 4" junction box is provided with the fixture. Matching surface mount conduit boxes are available as an option.

The Vekter is suitable for lighting footpaths, building facades, building entrances and parking areas around buildings.

This luminaire can be mounted in downward or upward positions.

To meet International Dark Sky criteria, 3000k or warmer LEDs must be selected and luminaire fix mounted (+/- 15° allowable to permit leveling).

Additional Options (Consult Factory For Pricing)

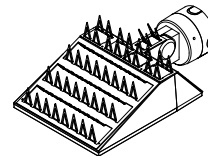

BS1
Bird Spikes
[Option 1]

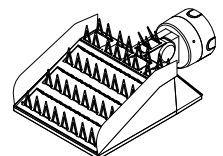

BS2
Bird Spikes
[Option 2]

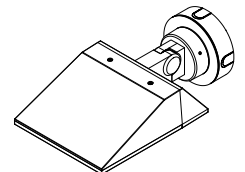
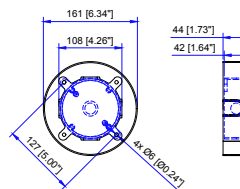

SCBT Surface Mount Box Trim

NOTE: This trim covers a shallow single gang, surface mount junction box [Provided by contractor]
 Example: Hubbell: - 5361-0 - 1-Gang Weatherproof Box, Five 1/2" In. Threaded Outlets - or - 5372-0 - 1-Gang Weatherproof Box, Five 3/4 In. Threaded Outlets

UVK-30022

Vektor 9 Medium Adjustable Arm



PROJECT		DATE	
----------------	--	-------------	--

QUANTITY		TYPE		NOTE	
-----------------	--	-------------	--	-------------	--

ORDERING EXAMPLE || UVK - 30022 - 28w - T2 - W30 - 02 - 120/277v - Options

UVK-30022					
LAMP	BEAM	LED COLOR	FINISH COLOR	VOLTAGE	
28w LED 3308 Lumens	T1 - Type I Distribution T2 - Type II Distribution T3 - Type III Distribution T4 - Type IV Distribution M - Medium 31° W - Wide 53° VW - Very Wide 66° EW - Extra Wide 110°	W27 - 2700K W30 - 3000K W35 - 3500K W40 - 4000K	01 - BLACK RAL 9011 02 - DARK GREY RAL 7043 03 - WHITE RAL 9003 04 - METALLIC SILVER RAL 9006 05 - MATTE SILVER RAL 9006 06 - LIGMAN BRONZE 07 - CUSTOM RAL	120/277v Other - Specify	

--	--	--

ADDITIONAL OPTIONS

- | | |
|---------------------------------|---------------------------------|
| NAT - Natatorium Rated | F - Frosted Lens |
| DIM - 0-10v Dimming | AMB - Turtle Friendly Amber LED |
| SCBT - Surface Conduit Box Trim | BS1 - Bird Spikes [Option 1] |
| EMR - Remote Emergency Pack | BS2 - Bird Spikes [Option 2] |

INSPIRED BY NATURE FINISHES

- SW01 - OAK FINISH
- SW02 - WALNUT FINISH
- SW03- PINE FINISH
- DF - DOUGLAS FIR FINISH
- CW - CHERRY WOOD FINISH
- NW - NATIONAL WALNUT FINISH
- SU01 - CONCRETE FINISH
- SU02 - SOFTSCAPE FINISH
- SU03 - STONE FINISH
- SU04 - CORTEN FINISH

THERE IS AN ADDITIONAL COST FOR THESE FINISHES

CITY OF FLAGSTAFF & TURTLE FRIENDLY COMPLIANT

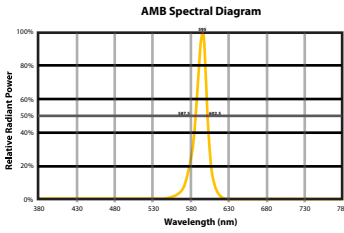

Narrow-Spectrum Amber LEDs
Peak wavelength between 585 & 595 nanometers and a full width of 50% power no greater than 15 nanometers.

More Custom Finishes Available Upon Request

Consult factory for pricing and lead times

Oak	Cherry	Beech	Carbon
Walnut	Chestnut	Bamboo	Galvanized
Pine	Mahogany	Birch	Steel



Ligman Lighting USA reserves the right to change specifications without prior notice, please contact factory for latest information. Due to the continual improvements in LED technology data and components may change without notice.



Vekter Product Family



Vekter 1

- UVK-30001-20w-2446lm
- UVK-30002-28w-3330lm



Vekter 2

- UVK-30003-37w-5143lm
- UVK-30004-54w-6954lm



Vekter 3

- UVK-10001-20w-2473lm
- UVK-10002-28w-3330lm



Vekter 4

- UVK-10011-2x20w-2x2473lm
- UVK-10012-2x28w-2x3330lm



Vekter 5

- UVK-90001-37w-5143lm
- UVK-90002-54w-6954lm



Vekter 6

- UVK-90011-2x37w-2x5143lm
- UVK-90012-2x54w-2x6954lm



Vekter 7

- UVK-30011-20w-2473lm
- UVK-30012-28w-3330lm



Vekter 8

- UVK-30031-37w-5143lm
- UVK-30032-54w-6954lm



Vekter 9

- UVK-30021-20w-2473lm
- UVK-30022-28w-3330lm



Vekter 10

- UVK-30041-37w-5143lm
- UVK-30042-54w-6954lm



Vekter 11 - 13.1'

- UVK-20001-20w-2473lm
- UVK-20002-28w-3330lm



Vekter 12 - 13.1'

- UVK-20003-37w-5143lm
- UVK-20004-54w-6954lm



Vekter 13 - 13.1'

- UVK-20011-2x20w-2x2473lm
- UVK-20012-2x28w-2x3330lm



Vekter 14 - 13.1'

- UVK-20013-2x37w-2x5143lm
- UVK-20014-2x54w-2x6954lm



Vekter 15

- UVK-90021-4x20w-4x2473lm
- UVK-90022-4x28w-4x3330lm



Vekter 16

- UVK-90031-4x37w-4x5143lm
- UVK-90032-4x54w-4x6954lm



Vekter 17 - 19.6'

- UVK-20021-20w-2473lm
- UVK-20022-28w-3330lm



Vekter 18 - 19.6'

- UVK-20023-37w-5143lm
- UVK-20024-54w-6954lm



Vekter 19 - 19.6'

- UVK-20031-2x20w-2x2473lm
- UVK-20032-2x28w-2x3330lm



Vekter 20 - 19.6'

- UVK-20033-2x37w-2x5143lm
- UVK-20034-2x54w-2x6954lm