

UMV-30042

Marvik 5 Surface Up/Downlight



Construction

Aluminum
Less than 0.1% copper content – Marine Grade 6060 extruded & LM6 Aluminum High Pressure die casting provides excellent mechanical strength, clean detailed product lines and excellent heat dissipation.

Pre paint
8 step degrease and phosphate process that includes deoxidizing and etching as well as a zinc and nickel phosphate process before product painting.

Memory Retentive -Silicon Gasket
Provided with special injection molded "fit for purpose" long life high temperature memory retentive silicon gaskets. Maintains the gaskets exact profile and seal over years of use and compression.

Thermal management
LM6 Aluminum is used for its excellent mechanical strength and thermal dissipation properties in low and high ambient temperatures. The superior thermal heat sink design by Ligman used in conjunction with the driver, controls thermal below critical temperature range to ensure maximum luminous flux output, as well as providing long LED service life and ensuring less than 10% lumen depreciation at 50,000 hours.

Surge Suppression
Standard 10kv surge suppressor provided with all fixtures.

BUG Rating
B0 - U4 - G0

Finishing
All Ligman products go through an extensive finishing process that includes fettling to improve paint adherence.

Paint
UV Stabilized 4.9Mil thick powder coat paint and baked at 200 Deg C. This process ensures that Ligman products can withstand harsh environments. Rated for use in natatoriums.

Inspired by Nature Finishes
The Inspired by nature Finishing is a unique system of decorative powder coating. Our metal decoration process can easily transform the appearance of metal or aluminum product into a wood grain finish.

This patented technology enables the simulation of wood grain, and even marble or granite finish through the use of decorative powder coating.

The wood grain finish is so realistic that it's almost undistinguishable from real wood, even from a close visual inspection. The system of coating permeates the entire thickness of the coat and as a result, the coating cannot be removed by normal rubbing, chipping, or scratching.

The Coating Process
After pre-treatment the prepared parts are powder coated with a specially formulated polyurethane powder. This powder provides protection against wear, abrasion, impact and corrosion and acts as the relief base color for the finalized metal decoration.

The component is then wrapped with a sheet of non-porous film with the selected decoration pattern printed on it using special high temperature inks.

This printed film transfer is vacuum-sealed to the surface for a complete thermo print and then transferred into a customized oven. The oven transforms the ink into different forms within the paint layer before it becomes solid. Finally, the film is removed, and a vivid timber look on aluminum remains.

Wood grain coating can create beautiful wood-looking products of any sort. There are over 300 combinations of designs currently in use. Wood grains can be made with different colors, designs, etc.

Our powder coatings are certified for indoor and outdoor applications and are backed by a comprehensive warranty. These coatings rise to the highest conceivable standard of performance excellence and design innovation.

- Added Benefits**
- Resistance to salt-acid room, accelerated aging
 - Boiling water, lime and condensed water resistant
 - Anti-Graffiti, Anti-Slip, Anti-Microbial, Anti-Scratch
 - Super durable (UV resistant)
 - TGIC free (non-toxic)

Hardware
Provided Hardware is Marine grade 316 Stainless steel.

Anti Seize Screw Holes
Tapped holes are infused with a special anti seize compound designed to prevent seizure of threaded connections, due to electrolysis from heat, corrosive atmospheres and moisture.

Crystal Clear Low Iron Glass Lens
Provided with tempered, impact resistant crystal clear low iron glass ensuring no green glass tinge.

Optics & LED
Precise optic design provides exceptional light control and precise distribution of light.
LED CRI > 80

Lumen - Maintenance Life
L80 /B10 at 50,000 hours (This means that at least 90% of the LED still achieve 80% of their original flux)

Cylindrical, single or double-sided wall family. Compact and decorative appearance belies powerful outputs and technical optics for perfect task illumination

A stunning new waterproof & dust proof wall cylinder range, designed with no visible fasteners, a one-piece body and integrated driver housing.

This smart mechanical modern designed luminaire with cylindrical body provides a stylish solution to wall mounted cylinders.

This innovative design houses a variety of COB wattages to suit designer's specific requirements as well as a selection of field interchangeable reflector optics, that include narrow, medium, wide and very wide distributions. This series is available in 3 different diameters, namely 3", 4" & 6" to suit lighting design requirements.

These luminaires are suitable for various facade lighting requirements along with accent lighting, building columns and architectural highlighting etc. The Marvik 1 protrudes 4" from the wall, making this product suitable for ADA applications.

This luminaire range can be provided with a bayonet lock baffle to reduce glare, as well as a frosted lens option. The SCE surface conduit entry box option can be provided as an option for an attractive solution to surface conduit entry.

Ligman can also provide custom made boxes to fit on a round surface like a column, pillar or pole.

2x10w LED 2x893 Lumens
IP65 • Suitable For Wet Locations
IK08 • Impact Resistant (Vandal Resistant)
Weight 6.2 lbs

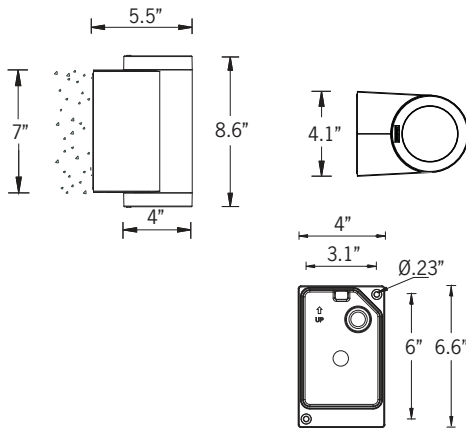

Mounting Detail



Ligman's micro Variable Optical System provides the ability to interchange, mix & rotate optics to provide specific light distributions for optimized spacing and uniformity.

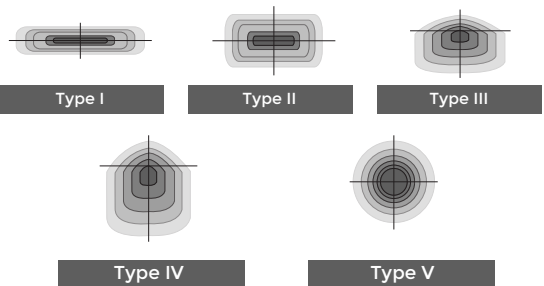

The variable optic system allows for the designer to create hybrid distributions for precise lighting requirements.

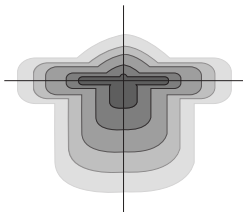

HYBRID TYPE I & TYPE IV

Additional Options (Consult Factory For Pricing)

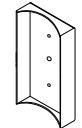

RPA
Round Pole Adapter



B
Baffle

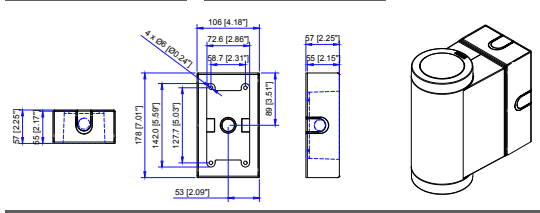

SCBT
Surface Conduit Box Trim

NOTE: This trim covers a shallow single gang, surface mount junction box [Provided by contractor]
Example: Hubbell - 5322-0 - 1-Gang Weatherproof Box, Five 1/2" in. Threaded Outlets - or - 5332-0 - 1-Gang Weatherproof Box, Five 3/4 in. Threaded Outlets

UMV-30042

Marvik 5 Surface Up/Downlight



PROJECT		DATE	
----------------	--	-------------	--

QUANTITY		TYPE		NOTE	
-----------------	--	-------------	--	-------------	--

ORDERING EXAMPLE || UMV - 30042 - 2x10w - M - W - W30 - 02 - 120/277v - Options

UMV-30042						
LAMP	BEAM UP	BEAM DOWN	LED COLOR	FINISH COLOR	VOLTAGE	
2x10w LED 2x893 Lumens	M - Medium 32" W - Wide 52" VW - Very Wide 65" EW - Extra Wide 108" T1 - Type I Distribution T2 - Type II Distribution T3 - Type III Distribution T4 - Type IV Distribution	M - Medium 32" W - Wide 52" VW - Very Wide 65" EW - Extra Wide 108" T1 - Type I Distribution T2 - Type II Distribution T3 - Type III Distribution T4 - Type IV Distribution	W27 - 2700K W30 - 3000K W35 - 3500K W40 - 4000K	01 - BLACK RAL 9011 02 - DARK GREY RAL 7043 03 - WHITE RAL 9003 04 - METALLIC SILVER RAL 9006 05 - MATTE SILVER RAL 9006 06 - LIGMAN BRONZE 07 - CUSTOM RAL	120/277v Other - Specify	

--	--	--

ADDITIONAL OPTIONS

- | | |
|---------------------------------|---------------------------------|
| NAT - Natatorium Rated | RPA - Round Pole Adapter |
| 4MP - 4" Mounting Plate | B - Baffle |
| DIM - 0-10v Dimming | AMB - Turtle Friendly Amber LED |
| SCBT - Surface Conduit Box Trim | |

INSPIRED BY NATURE FINISHES

- | | |
|-----------------------------|--|
| SW01 - OAK FINISH | |
| SW02 - WALNUT FINISH | |
| SW03 - PINE FINISH | |
| DF - DOUGLAS FIR FINISH | |
| CW - CHERRY WOOD FINISH | |
| NW - NATIONAL WALNUT FINISH | |
| SU01 - CONCRETE FINISH | |
| SU02 - SOFTSCAPE FINISH | |
| SU03 - STONE FINISH | |
| SU04 - CORTEN FINISH | |

THERE IS AN ADDITIONAL COST FOR THESE FINISHES

More Custom Finishes Available Upon Request

Consult factory for pricing and lead times

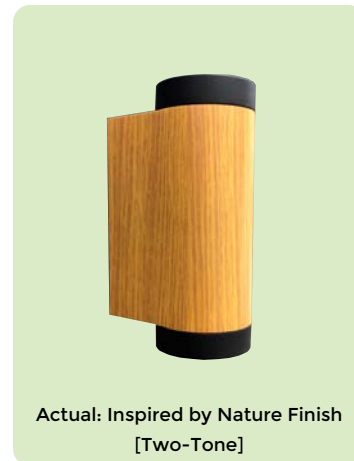

Marvik Product Family



Marvik 1

- UMV-30001-11w-976lm
- UMV-30002-20w-1674lm



Marvik 2

- UMV-30011-20w-1802lm
- UMV-30012-27w-2387lm
- UMV-30013-11w-1132lm



Marvik 3

- UMV-30021-40w-3795lm
- UMV-30022-48w-4622lm
- UMV-30023-20w-1627lm



Marvik 4

- UMV-30031-2x11w-2x976lm



Marvik 5

- UMV-30041-2x13w-2x1245lm
- UMV-30042-2x10w-2x893lm



Marvik 6

- UMV-30051-2x26w-2x2722lm
- UMV-30052-2x20w-2x1627lm

