

# UVK-20012

## Vektor 13 Medium Double Head Spike



2x28w LED  
2x3308 Lumens

Weight 123.8 lbs

IP65  
Suitable for wet locations

IK08  
Impact Resistant [Vandal Resistant]

EPA - 3.62

POLE INCLUDED

### Construction

#### Aluminum

Less than 0.1% copper content - Marine Grade 6060 extruded & LM6 Aluminum High Pressure die casting provides excellent mechanical strength, clean detailed product lines and excellent heat dissipation.

#### Pre paint

8 step degrease and phosphate process that includes deoxidizing and etching as well as a zinc and nickel phosphate process before product painting.

#### Memory Retentive - Silicon Gasket

Provided with special injection molded "fit for purpose" long life high temperature memory retentive silicon gaskets. Maintains the gaskets exact profile and seal over years of use and compression.

#### Thermal management

LM6 Aluminum is used for its excellent mechanical strength and thermal dissipation properties in low and high ambient temperatures. The superior thermal heat sink design by Ligman used in conjunction with the driver, controls thermals below critical temperature range to ensure maximum luminous flux output, as well as providing long LED service life and ensuring less than 10% lumen depreciation at 50,000 hours.

#### Surge Suppression

Standard 10kv surge suppressor provided with all fixtures.

#### BUG Rating

B2 - U0 - G0

#### Finishing

All Ligman products go through an extensive finishing process that includes fettling to improve paint adherence.

#### Paint

UV Stabilized 4.9Mil thick powder coat paint and baked at 200 Deg C. This process ensures that Ligman products can withstand harsh environments. Rated for use in natatoriums.

#### Inspired by Nature Finishes

The Inspired by nature Finishing is a unique system of decorative powder coating. Our metal decoration process can easily transform the appearance of metal or aluminum product into a wood grain finish.

This patented technology enables the simulation of wood grain, and even marble or granite finish through the use of decorative powder coating.

The wood grain finish is so realistic that it's almost undistinguishable from real wood, even from a close visual inspection. The system of coating permeates the entire thickness of the coat and as a result, the coating cannot be removed by normal rubbing, chipping, or scratching.

#### The Coating Process

After pre-treatment the prepared parts are powder coated with a specially formulated polyurethane powder. This powder provides protection against wear, abrasion, impact and corrosion and acts as the relief base color for the finalized metal decoration.

The component is then wrapped with a sheet of non-porous film with the selected decoration pattern printed on it using special high temperature inks.

This printed film transfer is vacuum-sealed to the surface for a complete thermo print and then transferred into a customized oven. The oven transforms the ink into different forms within the paint layer before it becomes solid. Finally, the film is removed, and a vivid timber look on aluminum remains.

Wood grain coating can create beautiful wood-looking products of any sort. There are over 300 combinations of designs currently in use. Wood grains can be made with different colors, designs, etc.

Our powder coatings are certified for indoor and outdoor applications and are backed by a comprehensive warranty. These coatings rise to the highest conceivable standard of performance excellence and design innovation.

#### Added Benefits

- Resistance to salt-acid room, accelerated aging
- Boiling water, lime and condensed water resistant
- Anti-Graffiti, Anti-Slip, Anti-Microbial, Anti-Scratch
- Super durable (UV resistant)
- TGIC free (non-toxic)

#### Hardware

Provided Hardware is Marine grade 316 Stainless steel.

#### Anti Seize Screw Holes

Tapped holes are infused with a special anti seize compound designed to prevent seizure of threaded connections, due to electrolysis from heat, corrosive atmospheres and moisture.

#### Crystal Clear Low Iron Glass Lens

Provided with tempered, impact resistant crystal clear low iron glass ensuring no green glass tinge.

#### Optics & LED

Precise optic design provides exceptional light control and precise distribution of light.  
LED CRI > 80

#### Lumen - Maintenance Life

L80 /B10 at 50,000 hours (This means that at least 90% of the LED still achieve 80% of their original flux)

**Flexible tapered column-mounted floodlighting and area luminaires. Sleek, angular, technical and powerful professional lighting solutions with a graceful twist.**

A slim wedge shaped pole mount area light with a variety of different distributions to suit lighting designer's requirements. This luminaire has been designed to provide excellent light distribution patterns using a low wattage LED package. The result is excellent spacing to mounting height ratios, with a uniform lighting layout that meets code requirements using less energy.

The Vektor can be utilized to suit specific light patterns using the asymmetrical type I, II, III, IV as well as symmetrical lens optics. Variations of these for precise light distribution requirements can be provided. An example of this is using a combination of Type II & Type IV distribution optics inside the same fixture.

Type V distributions in medium, wide, very wide & extra wide are available.

These fixtures are adjustable, and can also be aimed as floodlights to provide focus lighting in specific areas, as well as facade lighting.

This luminaire is suitable for most applications and complies to dark sky requirements when mounted in the horizontal position. Designed for lighting private roadways, car parks, exhibition areas, service stations and truck stops. Internal house side shields are available as an option.

To meet International Dark Sky criteria, 3000k or warmer LEDs must be selected and luminaire fix mounted (+/- 15° allowable to permit leveling).

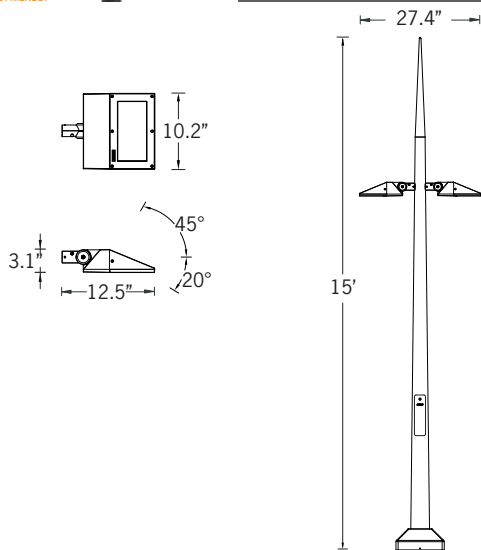

Ligman's micro Variable Optical System provides the ability to interchange, mix & rotate optics to provide specific light distributions for optimized spacing and uniformity.

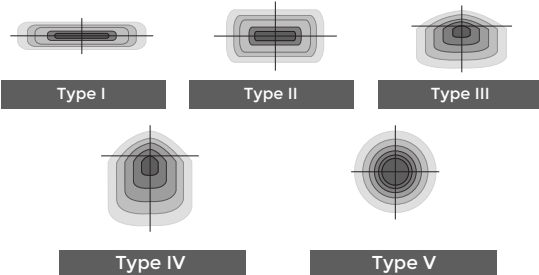

The variable optic system allows for the designer to create hybrid distributions for precise lighting requirements.

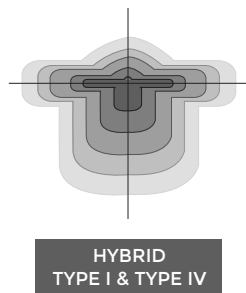

### CITY OF FLAGSTAFF & TURTLE FRIENDLY COMPLIANT

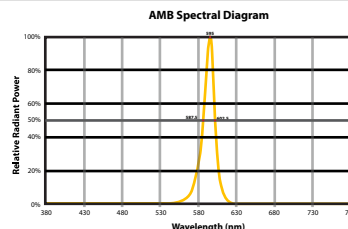

#### Narrow-Spectrum Amber LEDs

Peak wavelength between 585 & 595 nanometers and a full width of 50% power no greater than 15 nanometers.



# UVK-20012

Vektor 13 Medium Double Head Spike



<b>PROJECT</b>		<b>DATE</b>	
----------------	--	-------------	--

<b>QUANTITY</b>		<b>TYPE</b>		<b>NOTE</b>	
-----------------	--	-------------	--	-------------	--

ORDERING EXAMPLE || UVK - 20012 - 2x28w - T2 - W30 - 02 - 120/277v - Options

<b>UVK-20012</b>					
<b>LAMP</b>	<b>BEAM</b>	<b>LED COLOR</b>	<b>FINISH COLOR</b>	<b>VOLTAGE</b>	
2x28w LED 2x3308 Lumens	T1 - Type I Distribution T2 - Type II Distribution T3 - Type III Distribution T4 - Type IV Distribution M - Medium 32' W - Wide 52' VW - Very Wide 67' EW - Extra Wide 117'	W27 - 2700K W30 - 3000K W35 - 3500K W40 - 4000K	01 - BLACK RAL 9011 02 - DARK GREY RAL 7043 03 - WHITE RAL 9003 04 - METALLIC SILVER RAL 9006 05 - MATTE SILVER RAL 9006 06 - LIGMAN BRONZE 07 - CUSTOM RAL	120/277v Other - Specify	

**INSPIRED BY NATURE FINISHES**

- SW01 - OAK FINISH
- SW02 - WALNUT FINISH
- SW03- PINE FINISH
- DF - DOUGLAS FIR FINISH
- CW - CHERRY WOOD FINISH
- NW - NATIONAL WALNUT FINISH
- SU01 - CONCRETE FINISH
- SU02 - SOFTSCAPE FINISH
- SU03 - STONE FINISH
- SU04 - CORTEN FINISH

THERE IS AN ADDITIONAL COST FOR THESE FINISHES

## ADDITIONAL OPTIONS

- DIM - 0-10v Dimming
- NAT - Natatorium Rated
- WLC - Wireless Lighting Controls
- GFCI - GFCI Box
- AMB - Turtle Friendly Amber LED
- HSS - House Side Shield
- F - Frosted Lens
- HGT - Custom Height (Specify)
- OS - FSP Occupancy Sensor [See last page]
- FSIR - Occupancy Sensor Remote Programmer [See last page]

- A21381-BL - Blue Spike Light
- A21381-RD - Red Spike Light
- A21381-GR - Green Spike Light
- A21381-AM - Amber Spike Light
- A21381-W30 - W30 White Spike Light
- A21381-W40 - W40 White Spike Light
- A21481 - RGBW Spike Light



## More Custom Finishes Available Upon Request

Consult factory for pricing and lead times

 Oak	 Cherry	 Beech	 Carbon
 Walnut	 Chestnut	 Bamboo	 Galvanized
 Pine	 Mahogany	 Birch	 Steel



# Vekter Product Family



Vekter 1

- UVK-30001-20w-2446lm
- UVK-30002-28w-3330lm



Vekter 2

- UVK-30003-37w-5143lm
- UVK-30004-54w-6954lm



Vekter 3

- UVK-10001-20w-2473lm
- UVK-10002-28w-3330lm



Vekter 4

- UVK-10011-2x20w-2x2473lm
- UVK-10012-2x28w-2x3330lm



Vekter 5

- UVK-90001-37w-5143lm
- UVK-90002-54w-6954lm



Vekter 6

- UVK-90011-2x37w-2x5143lm
- UVK-90012-2x54w-2x6954lm



Vekter 7

- UVK-30011-20w-2473lm
- UVK-30012-28w-3330lm



Vekter 8

- UVK-30031-37w-5143lm
- UVK-30032-54w-6954lm



Vekter 9

- UVK-30021-20w-2473lm
- UVK-30022-28w-3330lm



Vekter 10

- UVK-30041-37w-5143lm
- UVK-30042-54w-6954lm



Vekter 11 - 13.1'

- UVK-20001-20w-2473lm
- UVK-20002-28w-3330lm



Vekter 12 - 13.1'

- UVK-20003-37w-5143lm
- UVK-20004-54w-6954lm



Vekter 13 - 13.1'

- UVK-20011-2x20w-2x2473lm
- UVK-20012-2x28w-2x3330lm



Vekter 14 - 13.1'

- UVK-20013-2x37w-2x5143lm
- UVK-20014-2x54w-2x6954lm



Vekter 15

- UVK-90021-4x20w-4x2473lm
- UVK-90022-4x28w-4x3330lm



Vekter 16

- UVK-90031-4x37w-4x5143lm
- UVK-90032-4x54w-4x6954lm



Vekter 17 - 19.6'

- UVK-20021-20w-2473lm
- UVK-20022-28w-3330lm



Vekter 18 - 19.6'

- UVK-20023-37w-5143lm
- UVK-20024-54w-6954lm



Vekter 19 - 19.6'

- UVK-20031-2x20w-2x2473lm
- UVK-20032-2x28w-2x3330lm



Vekter 20 - 19.6'

- UVK-20033-2x37w-2x5143lm
- UVK-20034-2x54w-2x6954lm

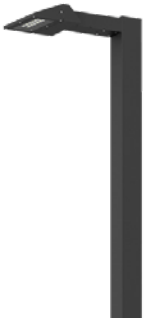

Vekter 25

- UVK-90041-20w-2473lm
- UVK-90042-28w-3330lm



Vekter 26

- UVK-90051-2x20w-2x2473lm
- UVK-90052-2x28w-2x3330lm



Vekter 27

- UVK-90061-37w-5143lm
- UVK-90062-54w-6954lm



Vekter 28

- UVK-90071-2x37w-2x5143lm
- UVK-90072-2x54w-2x6954lm



# HIGH/LOW/OFF PIR OUTDOOR PHOTO/MOTION SENSOR IP66 - Integrated photocell

Ligman provides integrated photocell control using the wattstopper legrand FSP-221B. These units are installed inside the fixture housing with only the external lenses being visible



FSP-221B

## Dimensions of Lens Options

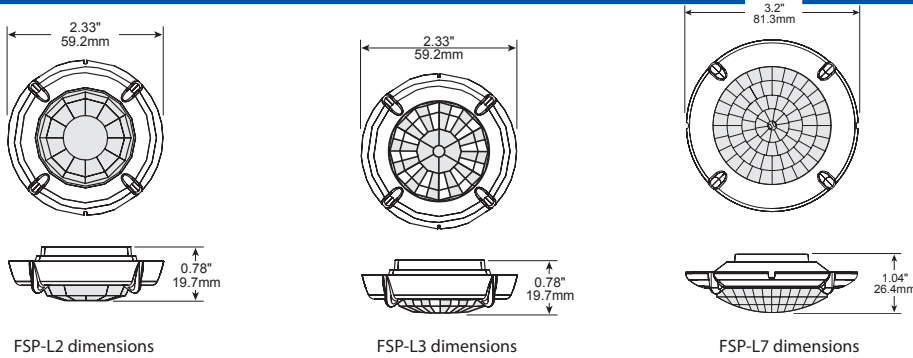

## Product Overview

The FSP-221B is a family of passive infrared (PIR) outdoor sensors that raise or lower the electric lighting level to high, low or off based on motion and/or daylight contribution. Typically, once the sensor stops detecting movement and the time delay elapses, lights will first fade to low mode, and eventually switch off. When motion is detected, the sensor ramps the light level to high mode unless the daylight contribution is sufficient.

The integral photocell can also switch the lights on and off for dusk to dawn control, so that lighting remains on overnight even without motion detection.

The sensors control 0-10VDC or nondimming LED drivers or ballasts.

The low voltage FSP-201B may be used with dim-to-off drivers or ballasts.

Initial setup and subsequent sensor adjustments are made using a Wireless Handheld Configuration Tool (FSIR-100). This tool enables adjustment of sensor parameters including high/low mode, sensitivity, time delay, cut off and more.

The FSIR-100 can read current parameter settings, and stores up to six sensor parameter profiles to speed commissioning of multiple sensors.

## Coverage

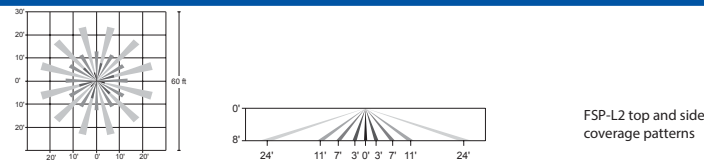

FSP-L2 top and side coverage patterns

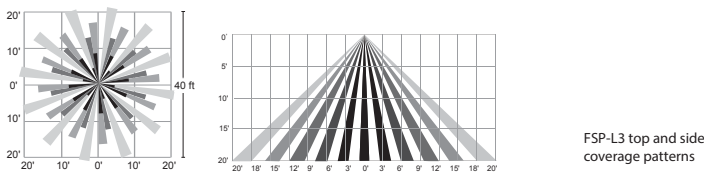

FSP-L3 top and side coverage patterns

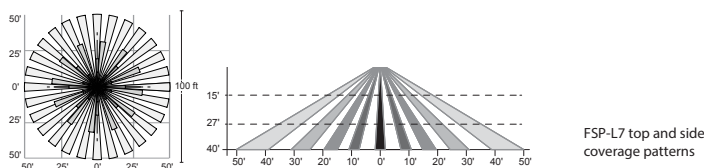

FSP-L7 top and side coverage patterns

## Models

FSP-221B, 100-347 VAC

## Specifications and Features



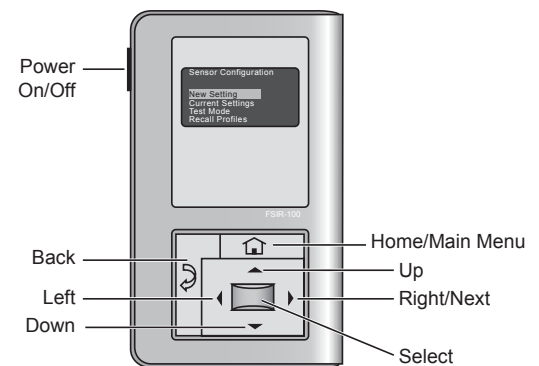

- Three interchangeable lenses for mounting between 8' and 40'
- Remote setup and adjustment with handheld wireless configuration tool
- Adjustable high and low modes (high: 0 to 10V, low: off, 0 to 9.8V)
- Adjustable time delay (30 seconds, 1 to 30 minutes)
- Adjustable cut off delay (none, 1 to 59 minutes, 1 to 5 hours)
- Adjustable sensitivity/service mode (low, med, max; on-fix, off-fix)
- Adjustable setpoints: hold off setpoint (none, 1 to 250 fc, auto); photocell on/off setpoint (1 to 250 fc)
- Adjustable ramp and fade times (1 to 60 seconds)
- Operating temperature: -40°F to +167°F (-40°C to +75°C)
- IP66 rated
- Five year warranty

## Factory Defaults

High mode:	10V
Low mode:	1V
Time delay:	5 minutes
Cut off:	1 hour
Setpoint:	Disabled
Sensitivity:	Max
Ramp up time:	Disabled
Fade down time:	Disabled
Photocell On/Off:	Disabled



The FSIR-100 is a convenient handheld remote tool for sensor setting. Adjustable settings can be changed as needed for specific applications.

Catalog #	Color	Description
 FSP-L2	White/Grey/Black/Brown <small>The Trim color option will be selected to closest match fixture color. e.g (Matte silver fixture - grey trim)</small>	360° lens, maximum coverage 48' diameter from 8' height
 FSP-L3	White/Grey/Black/Brown <small>The Trim color option will be selected to closest match fixture color. e.g (Matte silver fixture - grey trim)</small>	360° lens, maximum coverage 40' diameter from 20' height
 FSP-L7	White/Grey/Black/Brown <small>The Trim color option will be selected to closest match fixture color. e.g (Matte silver fixture - grey trim)</small>	360° lens, maximum coverage 100' diameter from 40' height
 FSIR-100	Black	Remote Handheld Configuration Tool