

# USAT-90011

## Santander Post Top

microVOS  
TECHNOLOGY

LIGMAN  
LIGHTING USA



28w LED  
2989 Lumens

IP66  
Suitable for wet locations

IK08  
Impact Resistant [Vandal Resistant]

EPA - 0.79

Weight - 28.6 lbs

POLE NOT INCLUDED



### Construction

**Aluminum**  
Less than 0.1% copper content - Marine Grade 6060 extruded & LM6 Aluminum High Pressure die casting provides excellent mechanical strength, clean detailed product lines and excellent heat dissipation.

**Pre paint**  
8 step decrease and phosphate process that includes deoxidizing and etching as well as a zinc and nickel phosphate process before product painting.

**Memory Retentive -Silicon Gasket**  
Provided with special injection molded "fit for purpose" long life high temperature memory retentive silicon gaskets. Maintains the gaskets exact profile and seal over years of use and compression.

**Thermal management**  
LM6 Aluminum is used for its excellent mechanical strength and thermal dissipation properties in low and high ambient temperatures. The superior thermal heat sink design by Ligman used in conjunction with the driver, controls thermals below critical temperature range to ensure maximum luminous flux output, as well as providing long LED service life and ensuring less than 10% lumen depreciation at 50,000 hours.

**Surge Suppression**  
Standard 10kv surge suppressor provided with all fixtures.

**BUG Rating**  
Refer to IES files or contact factory

**Finishing**  
All Ligman products go through an extensive finishing process that includes fettling to improve paint adherence.

**Paint**  
UV Stabilized 4.9Mil thick powder coat paint and baked at 200 Deg C. This process ensures that Ligman products can withstand harsh environments. Rated for use in natatoriums.

**Inspired by Nature Finishes**  
The Inspired by nature Finishing is a unique system of decorative powder coating. Our metal decoration process can easily transform the appearance of metal or aluminum product into a wood grain finish.

This patented technology enables the simulation of wood grain, and even marble or granite finish through the use of decorative powder coating.

The wood grain finish is so realistic that it's almost undistinguishable from real wood, even from a close visual inspection. The system of coating permeates the entire thickness of the coat and as a result, the coating cannot be removed by normal rubbing, chipping, or scratching.

**The Coating Process**  
After pre-treatment the prepared parts are powder coated with a specially formulated polyurethane powder. This powder provides protection against wear, abrasion, impact and corrosion and acts as the relief base color for the finalized metal decoration.

The component is then wrapped with a sheet of non-porous film with the selected decoration pattern printed on it using special high temperature inks.

This printed film transfer is vacuum-sealed to the surface for a complete thermo print and then transferred into a customized oven. The oven transforms the ink into different forms within the paint layer before it becomes solid. Finally, the film is removed, and a vivid timber look on aluminum remains.

Wood grain coating can create beautiful wood-looking products of any sort. There are over 300 combinations of designs currently in use. Wood grains can be made with different colors, designs, etc.

Our powder coatings are certified for indoor and outdoor applications and are backed by a comprehensive warranty. These coatings rise to the highest conceivable standard of performance excellence and design innovation.

- Added Benefits**
- Resistance to salt-acid room, accelerated aging
  - Boiling water, lime and condensed water resistant
  - Anti-Graffiti, Anti-Slip, Anti-Microbial, Anti-Scratch
  - Super durable (UV resistant)
  - TGIC free (non-toxic)

**Hardware**  
Provided Hardware is Marine grade 316 Stainless steel.

**Anti Seize Screw Holes**  
Tapped holes are infused with a special anti seize compound designed to prevent seizure of threaded connections, due to electrolysis from heat, corrosive atmospheres and moisture.

**Crystal Clear Low Iron Class Lens**  
Provided with tempered, impact resistant crystal clear low iron glass ensuring no green glass tinge.

**Optics & LED**  
Precise optic design provides exceptional light control and precise distribution of light.  
LED CRI > 80

**Lumen - Maintenance Life**  
L80 /B10 at 50,000 hours (This means that at least 90% of the LED still achieve 80% of their original flux)

### Modern, urban post top with open-head design hiding technically precise asymmetric and symmetric streetlight optics.

The Santander Pole Top luminaire combines aesthetics and focused, precision lighting with microVOS™ optics to provide a large range of light distributions and beam patterns.

This product is available with field interchangeable standard Type I, II, III, IV & V (Medium & Wide) distributions, as well as the ability to select specific quadrants within the luminaire and specify different distributions per quadrant.

An example of this could be Type II distributions in 2 quadrants left and Type IV distribution in the remaining quadrants right. This flexibility allows the lighting designer to utilize these optics and specifically place light where needed.

Utilizing this optical flexibility, a single luminaire could produce the same lighting solution and distributions as two separate luminaires on a single pole.

This product range is available in a 126w option, and can be configured for lower customer specific wattages. Contact the factory for more information.

To meet International Dark Sky criteria, 3000k or warmer LEDs must be selected.

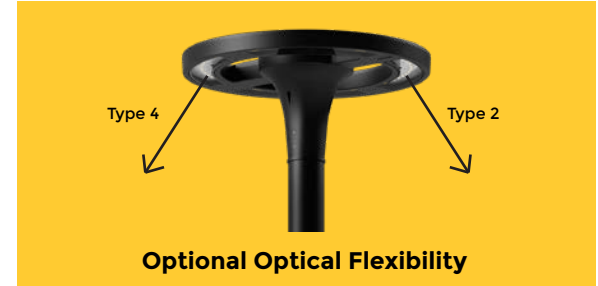

CITY OF FLAGSTAFF & TURTLE FRIENDLY COMPLIANT

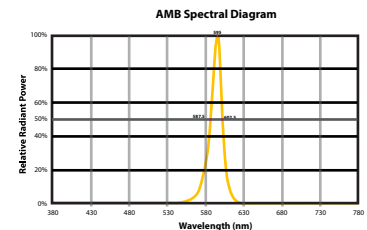

**Narrow-Spectrum Amber LEDs**  
Peak wavelength between 585 & 595 nanometers and a full width of 50% power no greater than 15 nanometers.

Additional Options (Consult Factory For Pricing)

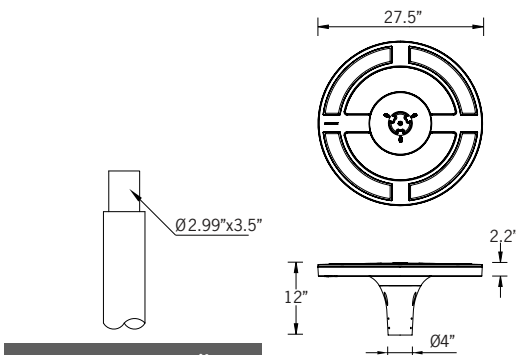

#### Tenon Detail

Use 4" or 4.5" diameter pole for smooth visual transition with pole top fixture.

microVOS  
TECHNOLOGY

Ligman's micro Variable Optical System provides the ability to interchange, mix & rotate optics to provide specific light distributions for optimized spacing and uniformity.

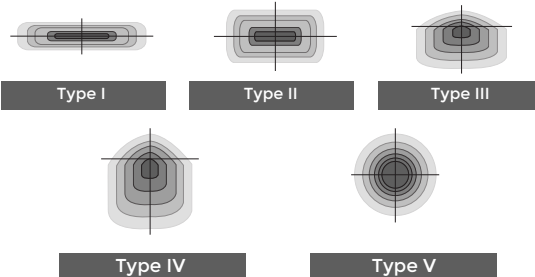

The variable optic system allows for the designer to create hybrid distributions for precise lighting requirements.

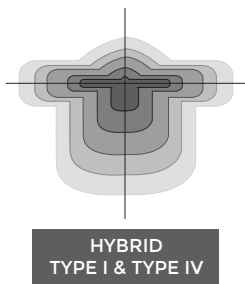

# USAT-90011

## Santander Post Top

<b>PROJECT</b>	<input type="text"/>	<b>DATE</b>	<input type="text"/>
----------------	----------------------	-------------	----------------------

<b>QUANTITY</b>	<input type="text"/>	<b>TYPE</b>	<input type="text"/>	<b>NOTE</b>	<input type="text"/>
-----------------	----------------------	-------------	----------------------	-------------	----------------------

ORDERING EXAMPLE || USAT - 90011 - 28w - T2 - W30 - 02 - 120/277v - Options

<b>USAT-90011</b>	<input type="text"/>	<input type="text"/>	<input type="text"/>	<input type="text"/>	<input type="text"/>
	<b>LAMP</b>	<b>BEAM</b>	<b>LED COLOR</b>	<b>FINISH COLOR</b>	<b>VOLTAGE</b>

28w LED  
2989 Lumens

T2 - Type II Distribution  
T3 - Type III Distribution  
T4 - Type IV Distribution  
M - Medium Beam 64°  
W - Wide Beam 86°  
C - Custom Distribution  
SELECT USING DRAWING BELOW

W27 - 2700K  
W30 - 3000K  
W35 - 3500K  
W40 - 4000K

01 - BLACK RAL 9011  
02 - DARK GREY RAL 7043  
03 - WHITE RAL 9003  
04 - METALLIC SILVER RAL 9006  
05 - MATTE SILVER RAL 9006  
06 - LIGMAN BRONZE  
07 - CUSTOM RAL

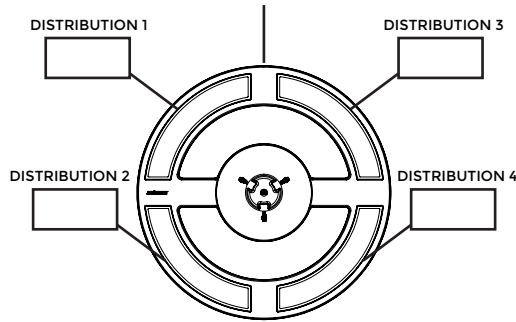
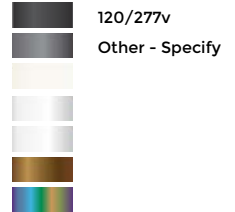

**INSPIRED BY NATURE FINISHES**

SW01 - OAK FINISH  
SW02 - WALNUT FINISH  
SW03 - PINE FINISH  
DF - DOUGLAS FIR FINISH  
CW - CHERRY WOOD FINISH  
NW - NATIONAL WALNUT FINISH  
SU01 - CONCRETE FINISH  
SU02 - SOFTSCAPE FINISH  
SU03 - STONE FINISH  
SU04 - CORTEN FINISH

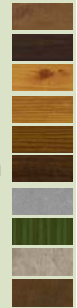

<input type="text"/>	<input type="text"/>	<input type="text"/>	<input type="text"/>
----------------------	----------------------	----------------------	----------------------

### ADDITIONAL OPTIONS

NAT - Natatorium Rated  
DIM - 0-10v Dimming

AMB - Turtle Friendly Amber LED  
RGBW - RGBW Santander

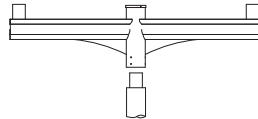
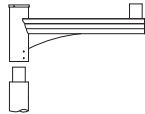
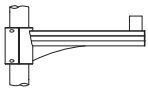

A20176  
Aluminum Arm Pole Clamp

A20276  
Aluminum Single Arm

A20376  
Aluminum Double Arm

### More Custom Finishes Available Upon Request

Consult factory for pricing and lead times



Example: Inspired by Nature Finish